

The Kingspan **KoolDuct**[®] System

GLOBAL SPECIFICATION MANUAL



Manufactured to BS EN ISO 9001: 2000
Certificate No. 388



Low Energy –
Low Carbon Buildings

Contents

	Page
Introduction	3
Prestige Projects	4
System Benefits	14
Product Data	22
Issues to Consider	
Whole Life costs	24
Economy of Duct Design	25
Weight	26
Installation Speed	28
Energy & Running Costs	30
Moisture & Exacerbated Heat Loss / Gain	32
Sustainability	34
Embodied Energy	36
Project Specification	38
UK & Ireland (Appendix A)	41
Australia (Appendix B)	46
Middle East (Appendix C)	52
North America (Appendix D)	58

Introduction

Overview

The Heating, Ventilation, and Air Conditioning (HVAC) industry is in the midst of a dynamic era. However, air distribution ductwork, a critical component of HVAC systems, has remained virtually unchanged since the early 1900's. Several factors and recent innovations have introduced the need to revolutionise air distribution ductwork. Building materials and insulating products have dramatically improved. Requirements for clean air are becoming increasingly stringent. Energy use has continued to escalate. Speed of construction has become a valuable asset. Floor space and headroom are under constant pressure.

The *Kingspan KoolDuct® System* is like no other insulated ductwork system. It is the most advanced and innovative System of pre-insulated air distribution ductwork available worldwide. The *Kingspan KoolDuct® System* of pre-insulated ductwork is a proven, innovative product that is easy to install and maintain, providing a new perspective in the field of air distribution.

Kingspan KoolDuct® rigid phenolic insulation panels have been produced since the early 1990's and have been used in the manufacture of ductwork from the *Kingspan KoolDuct® System* worldwide. The components and techniques that are associated with the fabrication of ductwork from the *Kingspan KoolDuct® System* have been established in the European marketplace since the mid 1960's.

This fourth generation *Kingspan KoolDuct® System* virtually eliminates all the problems of traditional metal ductwork while at the same time offering extra advantages to both the consulting / mechanical engineer and the fabricator / installer. The System is the clear leader in the new generation of insulated pre-fabricated ductwork and has already proved itself in the highly competitive global marketplace.

What's Different About the *Kingspan KoolDuct® System*?

Traditionally, air distribution ductwork is made of sheet metal which is installed first and then insulated separately as a second operation. *Kingspan KoolDuct® System* pre-insulated ductwork is installed in a single fix.

The *Kingspan KoolDuct® System* comprises either 3 m / 10 ft or 4 m / 13 ft long ductwork sections fabricated from rigid phenolic insulation panels with aluminium surfaces.



Prestige Projects

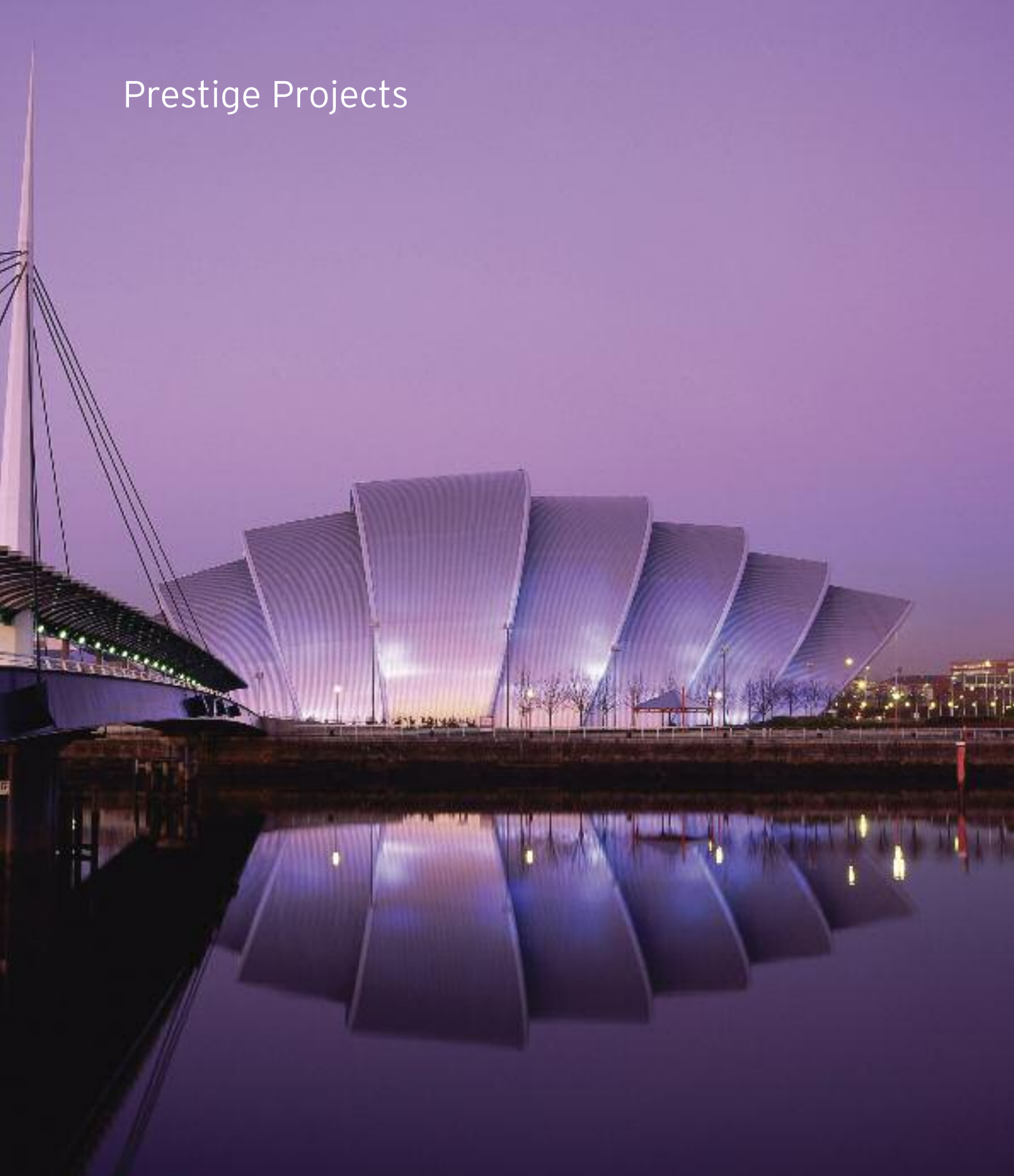

Project Name: SECC
Location: Glasgow, Scotland, UK
Building Use: Exhibition Conference Centre
M&E Consulting Engineer: Hulley Kirkwood
M&E Contractors: Brankin Engineering

Project Name: Shangri-La Hotel
Location: Dubai, UAE
Volume: 10,000 m²
Building Use: Hotel
M&E Consulting Engineer: NORR Group Consultants International
M&E Contractor: Sensaire Services
Main Contractor: Al Habtoor Engineering / Murray & Roberts



Prestige Projects



Project Name:	BBC Glasgow
Location:	Scotland, UK
Building Use:	Broadcast Centre & Offices
M&E Consulting Engineer:	Arup
M&E Contractors:	Balfour Kilpatrick
Fabricator / Installer:	Ductform Ventilation UK Ltd



Prestige Projects

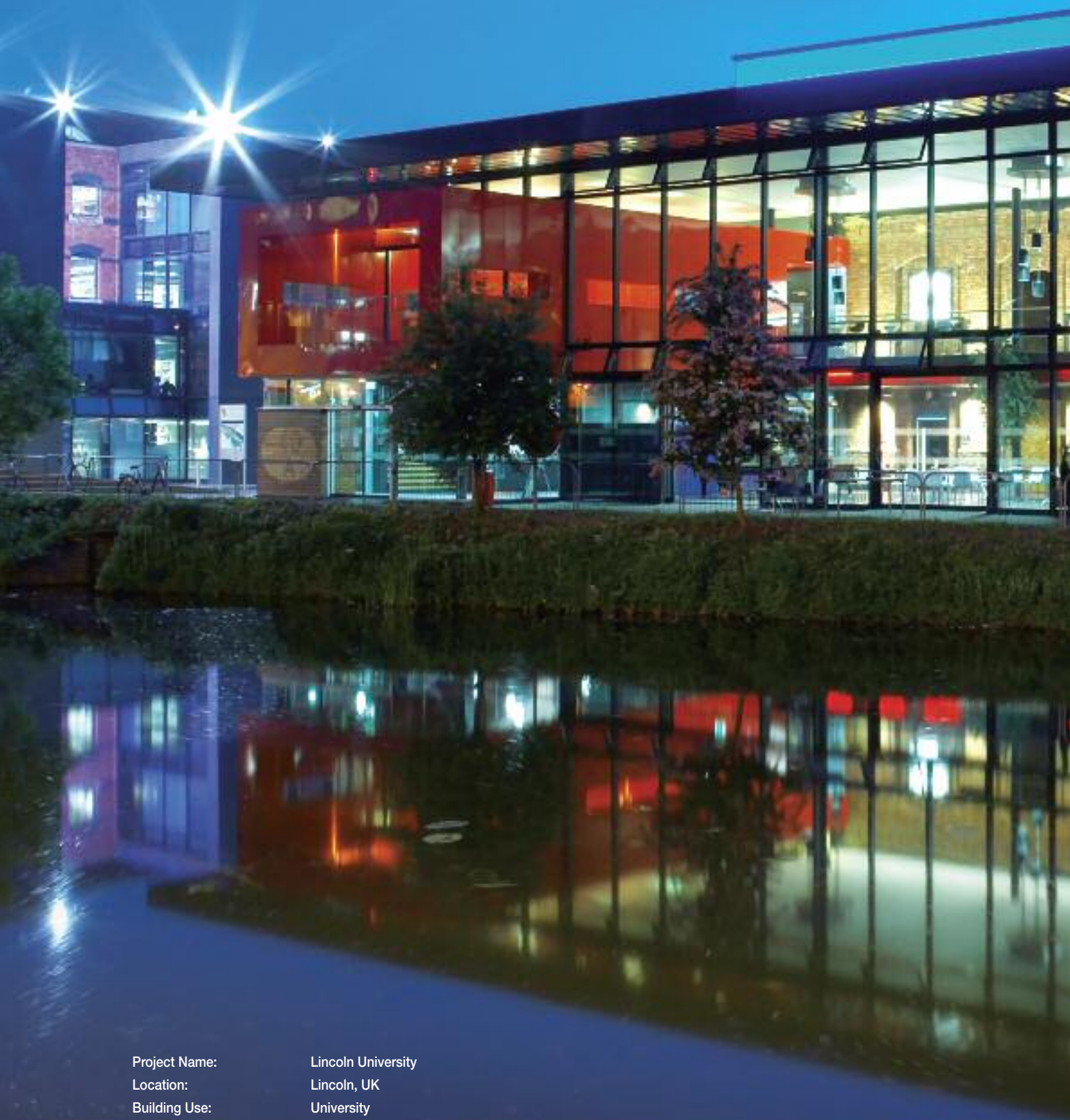

Project Name:	Lincoln University
Location:	Lincoln, UK
Building Use:	University
M & E Consulting Engineer:	HBG
Installer / Fabricator:	Ducted Air Systems Ltd.



Prestige Projects



Project Name:	Queen Mary College Hospital, UK
Location:	London, UK
Volume:	3000 m ²
Building Use:	University Medical School
M&E Consulting Engineer:	WSP
M&E Contractor:	Crown House Engineering
Installer / Fabricator:	Hotchkiss Ductwork



Prestige Projects



Project Name:	Atlantis, The Palm, Dubai
Location:	Dubai, UAE
Volume:	13,650 m ²
Building Use:	Hotel Resort
M&E Consulting Engineer:	NORR Group Consultants International
M&E Contractor:	BK Gulf LLC / Rotary HUMM Services LLC
Fabricator:	Seagull HVAC Industry LLC



Project Name:	Darwin Centre, Natural History Museum
Location:	London, UK
Volume:	1200 m ²
Building Use:	Museum / Research & Collections Facility
M&E Consulting Engineer:	Fulcrum Consulting
M&E Contractor:	Imtech Meica Ltd
Fabricator / Installer:	RDS

System Benefits

Whole Life Costs

'Whole life' costing takes account of the total cost of an item over its life, including durability, energy savings and maintenance as well as initial purchase price.

Independent consultants, Cyril Sweett, carried out an analysis of the 'whole life' costs of differing HVAC ductwork specifications. The research showed that the installation of the **Kingspan KoolDuct® System** can save up to 21% on capital cost. Furthermore, over a 30 year life, the **Kingspan KoolDuct® System** can also make a saving of over 20% on operating costs.

For further information on the benefits of the System's 'whole life' costs, please refer to the Issues to Consider section of this document.

Installed Cost

Research, by independent consultants Rider Levett Bucknall, continues to show that the installed cost of the **Kingspan KoolDuct® System** is cheaper than that of insulated sheet metal ductwork; up to 19% cheaper for larger ducts. This research, carried out in the UK, compared ductwork sections fabricated from 22 mm / 7/8" and 33 mm / 1 5/16" **Kingspan KoolDuct®** rigid phenolic insulation panels and the 4-bolt flange jointing system, with 40 mm / 1 9/16" and 55 mm / 2 3/16" mineral fibre insulated galvanised sheet steel ductwork.

Unit	Price (£)			
	KoolDuct® 22 mm / 7/8" (4-bolt Flange)	Galvanised Sheet Steel Duct and Mineral Fibre 40 mm / 1 9/16" mm	KoolDuct® 33 mm / 1 5/16" (4-bolt Flange)	Galvanised Sheet Steel Duct and Mineral Fibre 55 mm / 2 3/16"
200 mm x 200 mm / 8" x 8" Duct Size				
Straight Duct / lin. m	47-56	48-58	50-60	58-68
Per Shoe	30-40	30-40	30-40	32-42
Per 45° Bend	38-48	30-40	42-52	32-42
Per Taper	37-47	35-45	38-48	37-45
Per Sq90	41-50	35-45	46-56	37-45
All in Rate / lin. m	72-82	72-82	78-88	82-92
400 mm x 400 mm / 16" x 16" Duct Size				
Straight Duct / lin. m	75-85	85-95	85-95	90-100
Per Shoe	40-50	47-58	42-52	48-58
Per 45° Bend	58-68	67-76	63-73	67-77
Per Taper	47-57	63-73	50-60	65-75
Per Sq90	65-75	86-95	70-80	88-98
All in Rate / lin. m	95-105	110-120	107-117	115-125
600 mm x 600 mm / 24" x 24" Duct Size				
Straight Duct / lin. m	105-115	120-130	118-128	126-136
Per Shoe	52-62	75-85	55-65	75-85
Per 45° Bend	86-96	115-125	93-103	118-128
Per Taper	62-70	85-95	63-73	88-98
Per Sq90	96-105	143-153	103-113	145-155
All in Rate / lin. m	137-145	160-170	150-160	165-175
1000 mm x 1000 mm / 39" x 39" Duct Size				
Straight Duct / lin. m	160-170	195-205	185-195	195-205
Per Shoe	84-93	155-165	88-98	157-167
Per 45° Bend	152-160	215-225	165-175	220-228
Per Taper	88-95	145-155	92-102	150-160
Per Sq90	176-185	283-293	195-205	285-295
All in Rate / lin. m	185-195	230-240	210-220	240-250

The table below left shows indicative April 2007 installed costs in GBP (£) for a variety of sizes of ductwork sections, as reported by Rider Levett Bucknall. The rates are inclusive of allowances for the cost of insulation and the first level support members.

For ductwork sections in excess of 200 mm x 200 mm / 8" x 8", prices for the **Kingspan KoolDuct® System** become increasingly more competitive as the size of the ductwork section increases.

A rise in world steel prices from the April 2007 level will further increase the competitiveness of the **Kingspan KoolDuct® System**, potentially significantly.

Additionally, further savings on the **Kingspan KoolDuct® System** prices quoted could be available through volume discounts on major projects.

Rider Levett Bucknall also reported a general increase in the market share for the **Kingspan KoolDuct® System** as construction industry customers have become familiar with the product and the benefits its use brings.

A key factor in the differences shown in the table left is in the cost of the ductwork supports. In most circumstances, ductwork constructed using the **Kingspan KoolDuct® System** can be supported on a gripper wire assembly or threaded steel rods. Sheet steel ductwork requires a more robust support system utilising Unistrut type systems or, for larger sized ductwork and support spans, rolled steel angle or channel sections.

*A copy of the Rider Levett Bucknall report is available upon request from the Kingspan Insulation Marketing Department on +44 (0) 870 733 8333.

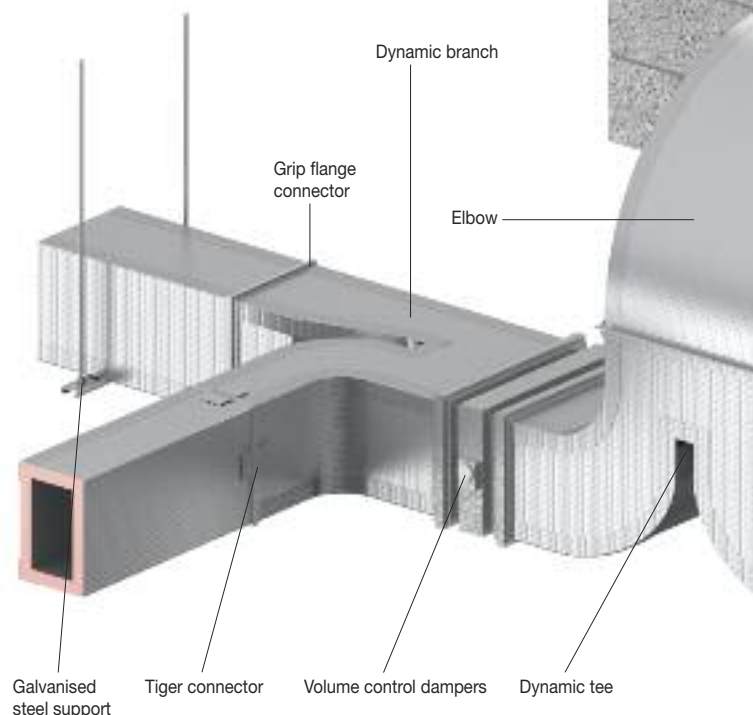

Weight

The exceptional strength to weight ratio of the *Kingspan KoolDuct®* System of pre-insulated ductwork results in ductwork that is lightweight, easy to handle and install. It can be seen from the table to the right that ductwork sections fabricated from *Kingspan KoolDuct®* rigid phenolic insulation panels can weigh up to 85% less than insulated galvanised sheet steel ductwork. This results in easier installation and much lower handling costs because fewer people are required to install a ductwork section. Two individuals can quickly and easily install substantially sized ductwork sections fabricated from the *Kingspan KoolDuct®* System of pre-insulated ductwork.

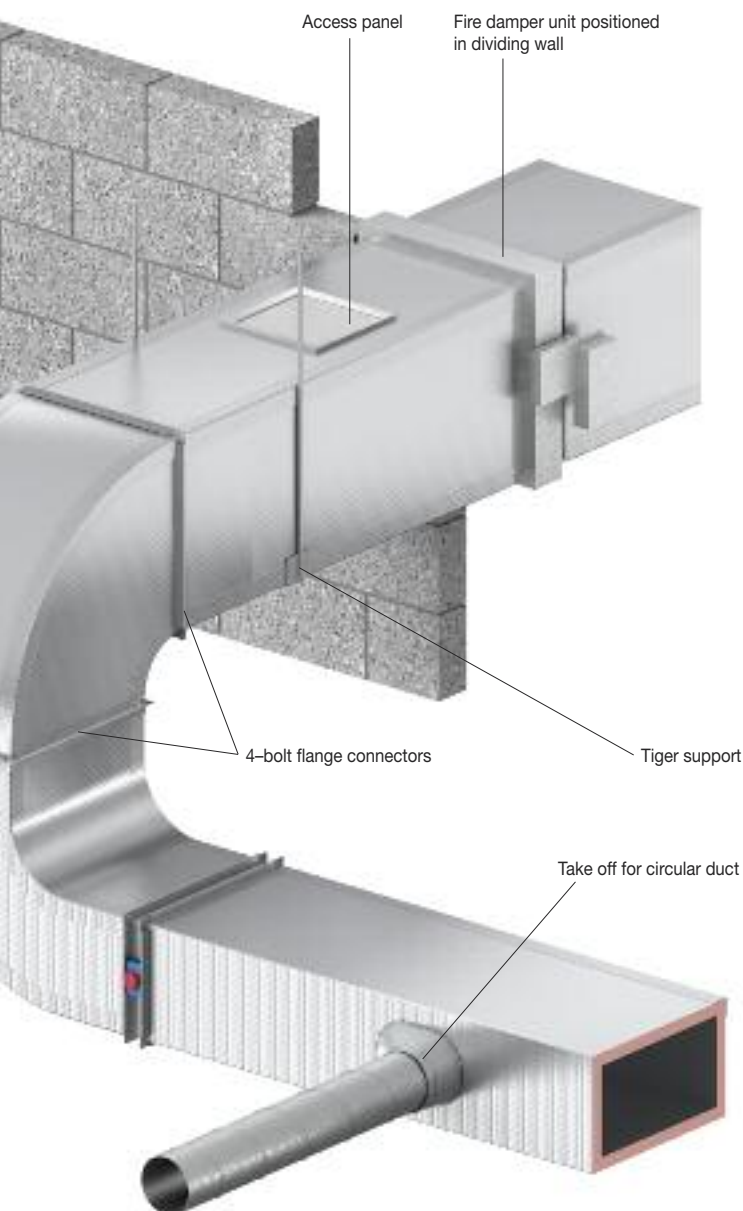

Specification	<i>Kingspan KoolDuct®</i>		Galvanised Sheet Steel Insulated with Mineral Fibre		Weight Reduction (%)
	Insulation Thickness	Ductwork Weight	Insulation Thickness	Ductwork Weight	
TIMSA Warm Air	22 mm	5.5 kg	29 mm	37.7 kg	85.3
TIMSA Chilled Air & Dual Purpose	30 mm	7.6 kg	50 mm	41.8 kg	81.8
BS 5422: 2001 Warm Air with 10°C ΔT	22 mm	5.5 kg	34 mm	38.6 kg	85.7
BS 5422: 2001 Warm Air with 15°C ΔT	22 mm	5.5 kg	37 mm	39.2 kg	85.9
BS 5422: 2001 Warm Air with 25°C ΔT	30 mm	7.6 kg	44 mm	40.6 kg	81.3
BS 5422: 2001 Chilled Air at 15°C	22 mm	5.5 kg	35 mm	36.9 kg	85.0
BS 5422: 2001 Chilled Air at 12°C	22 mm	5.5 kg	37 mm	39.2 kg	85.9
BS 5422: 2001 Chilled Air at 10°C	30 mm	7.6 kg	45 mm	40.8 kg	81.4
BCA 2008 Spec. J5.2-3 Table 3b	22 mm	5.5 kg	38 mm	35.7 kg	84.5
	30 mm	7.6 kg	50 mm	36.9 kg	79.4
	33 mm	8.4 kg	75 mm	39.4 kg	78.7
ANSI / ASHRAE / IESNA 90.1: 2007	7/8"	12.1 lb	1 1/2"	75.2 lb	83.8
	7/8"	12.1 lb	2 3/8"	77.4 lb	84.2
	1 1/8"	16.8 lb	3"	79.8 lb	79.0

Assumptions used are identical to those used in creating the table for the Embodied Energy chapter of the Issues to Consider section of this document.

Table Showing the Weight Reduction of *Kingspan KoolDuct®* over Galvanised Sheet Steel Insulated with Mineral Fibre for a 1 m / 3.3 ft Long Ductwork Section to Various Specifications

Many older buildings involved in refurbishment projects may not be designed to support the additional weight of insulated sheet steel ductwork. The *Kingspan KoolDuct®* System can generally alleviate the requirement for additional structural support.

Research, by independent consultants Rider Levett Bucknall, into a selection of UK refurbishment projects using the aluminium grip flange jointing system and 22 mm / 7/8" panel thickness, has shown that the main reason for specifying the *Kingspan KoolDuct®* System is that it can overcome severe constraints on structural loadings.

In these circumstances, the selection of the *Kingspan KoolDuct®* System over a galvanised sheet steel ductwork system was often the only realistic choice: the alternative normally being the introduction, at potentially significant additional cost, of secondary steel supports to transfer service loads back to the structure. In some projects, even this option was not available for example, where buildings contained features of architectural or historic importance that could not be obscured by the introduction of new structural members.

For further information on the benefits of the System's light weight, please refer to the Issues to Consider section of this document.

System Benefits

Installation Speed

The *Kingspan KoolDuct®* System has a single fix installation, by virtue of eliminating the manual process of applying the insulation around the ductwork as a separate operation, thus reducing site time and contractor management. The ability to fabricate up to 3 m / 10 ft or 4 m / 13 ft long sections rather than 1.2 m / 4 ft or 1.5 m / 5 ft long sections as in the case of sheet steel ductwork, means fewer sections and less handling. This coupled with increased support centres and ease of handling results in a fast track installation.



Research, by independent consultants Rider Levett Bucknall, into a selection of UK refurbishment projects showed that the main reason for choosing the *Kingspan KoolDuct®* System is that, when using the aluminium grip flange jointing system and 22 mm / 7/8" panel thickness, it can be installed up to three times faster than sheet steel ductwork – not even taking into account the manual process of applying the insulation around the ductwork as a separate operation. Rider Levett Bucknall also concluded that the 4-bolt flange is even faster to install than the aluminium grip flange and that panel thickness has no effect on the speed of installation of the System. Faster installation obviously means lower costs and less disruption for other trades.

For further information on the benefits of the System's high speed of installation, please refer to the Issues to Consider section of this document.

Space

The *Kingspan KoolDuct®* System is space saving by virtue of eliminating the space required for the manual process of applying the insulation above the ductwork as a separate operation. *Kingspan KoolDuct®* System ductwork can be installed flush to the ceiling. This can typically save 150–200 mm / 6–8" of valuable space above a false ceiling. Thinner insulation, because of the incomparable insulating efficiency of *Kingspan KoolDuct®* rigid phenolic insulation panels, further contributes to increased space savings.

Independent consultants, Rider Levett Bucknall, carried out an independent cost analysis of the benefits that the above mentioned space saving facility has on floor to floor dimensions in UK multi-storey buildings*. The results of this analysis showed that if floor to floor heights can be reduced to take advantage of these space saving facilities, the use of *Kingspan KoolDuct®* as part of a VAV (Variable Air Volume) air conditioning system can save 1–2% in overall project construction cost. This saving comes predominantly from reduced structure, cladding and internal wall and wall finishing costs.

*A copy of the Rider Levett Bucknall report is available upon request from the Kingspan Insulation Marketing Department on +44 (0) 870 733 8333.

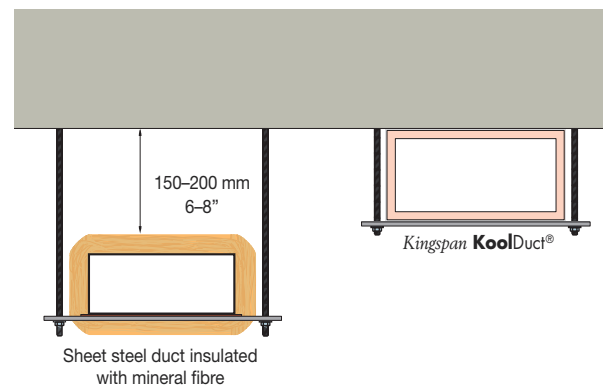

Air Leakage / Energy / Running Costs

The *Kingspan KoolDuct®* System technology, the fabrication methodology combined with the jointing systems and the complete line of bespoke accessories produce a system where the air leakage can be reduced to a fraction of that typical of sheet metal ductwork. For systems designed to withstand a static pressure of up to and including 1000 Pa / 4 in.w.g., the *Kingspan KoolDuct®* System can easily meet the air leakage requirements as shown in the table below.

Air Leakage Standard	Jointing System		
	Aluminium Grip	4-bolt	Tiger Connector
BS EN 13403: 2003	Class C	Class C	Class C
BS EN 1507: 2006	Class C	Class C	Class D
HVCA DW/144	Class C	Class C	Class C
SMACNA	Class 3	Class 3	Class 3

NB BS EN 13403: 2003 (Ventilation for buildings. Non metallic ducts. Ductwork made from insulation ductboards) is not applicable to sheet metal ductwork.

Standard sheet metal ductwork leaks air – most meets the air leakage requirements of Class 24 (SMACNA – HVAC Air Duct Leakage Test Manual) and Class A (HVCA DW/144 – Specification for Sheet Metal Ductwork and BS EN 1507: 2006 – Ventilation for buildings. Sheet metal ducts with rectangular section. Requirements for strength and leakage). It can be difficult to get sheet metal ductwork to achieve the air leakage requirements of Class 3 (SMACNA) and Class C (HVCA DW/144 and BS EN 1507: 2006). The superior insulation properties of *Kingspan KoolDuct*[®] rigid phenolic insulation panels, combined with the minimal air leakage of the *Kingspan KoolDuct*[®] System, can yield significant electrical consumption savings because of reduced heating and cooling loads.

Independent consultants, Rider Levett Bucknall, estimated the effect on fan power of different ductwork air leakage rates, using the results of testing conducted by BSRIA. The research showed that the use of the *Kingspan KoolDuct*[®] System can save over 30% on the annual electricity cost of running a fan.

The *Kingspan KoolDuct*[®] System can provide the optimum energy saving and environmental solution in comparison with other ductwork systems.

For further information on the benefits of the System's low air leakage, please refer to the Issues to Consider section of this document.

Moisture & Exacerbated Heat Loss / Gain

Kingspan KoolDuct[®] rigid phenolic insulation panels are faced on both sides with an aluminium foil vapour barrier jacket, which makes them highly resistant to moisture penetration. The risk of moisture penetration from damage to the aluminium foil vapour barrier jacket is considerably reduced as the rigid phenolic insulation core of the *Kingspan KoolDuct*[®] panels is of 'closed cell' construction.

Mineral fibre insulants are open structured materials which rely largely on entrapped still air for much of their insulating power. They can have little long term resistance to water and may have no resistance to vapour flow. Thus, the potential for moisture absorption can be extremely high if the factory applied vapour barrier jacket is either damaged or inadequately sealed.

Research has been undertaken to study the effect of moisture on mineral fibre insulants and has concluded that 1% moisture content by volume, within mineral fibre, can increase the thermal conductivity of the material by up to 107%. Such increases in the thermal conductivity of the mineral fibre insulation could have a very significant impact on the level of heat loss or gain on a building services installation.

For further information on the above, please refer to the Issues to Consider section of this document.

Sustainability

It is now known that the embodied environmental impacts of all of the materials and labour used to create a building are insignificant in comparison with the lifetime operational environmental impacts of that building and so are of very limited importance. Therefore, saving energy by specifying the lowest heat loss / gain and ductwork air leakage standards possible is the most environmentally sustainable action to take if specifying ductwork. As shown left the *Kingspan KoolDuct*[®] System leads the field in this respect.

Furthermore, the longevity of a building's standards of operational energy use, and therefore the longevity of its operational environmental impacts, is critical. The performance of some insulants, such as mineral fibre, can deteriorate rapidly if exposed to water penetration, air movement or compression. This may increase operational energy use and hence compromise the environmental sustainability of the finished building to an alarming degree. Rigid phenolic insulation is considerably less vulnerable to any of these problems than mineral fibre.

The *Kingspan KoolDuct*[®] System is therefore arguably the most environmentally sustainable ducting technology available.

But there is far more to sustainability than whether or not a product, process or company affects the environment in a positive or a negative way. A company can and should demonstrate its financial viability and social responsibility, as well as ensure that its materials and methods do not unduly add to the burden placed on the planet.

Kingspan Insulation carries out rigorous independent appraisals of the economic, social, environmental and natural resource impacts of the manufacturing facility that makes *Kingspan KoolDuct*[®] rigid phenolic insulation panels by using Arup's SPeAR[®] tool. Kingspan Insulation was the first construction material manufacturer in the UK to take this bold step and openly publish the results.

For further information on the above, please refer to the Issues to Consider section of this document.

System Benefits

Embodied Energy

Since the embodied environmental impacts of all of the materials and labour used to create a building are insignificant in comparison with the lifetime operational environmental impacts of that building, embodied energy is therefore usually irrelevant in the specification of insulating products.

However, even though mineral fibre manufacturers are aware of this, they persist in using embodied energy as a platform to promote their products.

The embodied energy content of mineral fibre and rigid phenolic insulants vary significantly. Some mineral fibre insulants have been quoted as having an embodied energy content of 13–26 MJ/kg whilst rigid phenolic insulation is quoted as having an embodied content of 100 MJ/kg. Whilst these figures would seem to suggest that the mineral fibre insulant is the more environmentally friendly product, as it has the lower energy content per kilogram, this is not the case.

In comparing the embodied energies of materials, the concept of a functional unit must be taken into account. In the case of ductwork insulation the functional unit depends upon firstly, the density of the insulation and secondly, the thickness of insulation required to achieve a defined heat loss / gain. This thickness will vary depending upon the thermal conductivity of the insulation material.

If a comparison is to be made between the *Kingspan KoolDuct® System* and conventional galvanised sheet steel ductwork insulated with different materials, then the functional unit must not only include the insulation as specified above but also, in the case of conventional ductwork, the sheet metal as it is absent from the *Kingspan KoolDuct® System*.

On this basis, the embodied energy of the *Kingspan KoolDuct® System* can be less than that for galvanised sheet steel insulated with mineral fibre (up to 30% less).

For further information on the above, please refer to the Issues to Consider section of this document.



UL Listed

The *Kingspan KoolDuct® System* is UL Listed as a Class 1 Air Duct to Standard for Safety UL 181 (Underwriters Laboratories Factory Made Air Ducts and Air Connectors). To meet Class 1 Air Duct requirements, the System must withstand rigorous physical tests e.g. surface burning characteristics; flame penetration; mould growth and humidity; puncture; pressure; erosion; static load; air leakage; impact; collapse; density; low temperatures; and high temperatures.

The UL Mark is a globally recognised symbol that provides assurance in the safety of a product in its application.

The *Kingspan KoolDuct® System* is the only rigid phenolic pre-insulated ductwork system in the world to be UL Listed.



Application Versatility

The *Kingspan KoolDuct® System* is available in the following wall thicknesses to suit different performance specifications:

- 22 mm / 7/8";
- 30 mm / 1 3/16"; and
- 33 mm / 1 5/16".

Different jointing systems are available to meet the requirements of different markets. They include the tiger connector system, the 4-bolt flange system and the aluminium grip flange system.

Kingspan KoolDuct® System ductwork can be installed internally, externally, concealed above a false ceiling or visibly mounted. It can also be installed in very high temperature and relative humidity ambient operating conditions.

Kingspan KoolDuct® System ductwork is specified for use in residential, commercial, institutional and industrial applications, and is especially suitable for applications such as swimming pools (contact Kingspan Insulation Ltd for details), food industries, pharmaceutical, special clean air / hygiene controlled environments and hospitals. The System is especially suited to refurbishment projects as well as new build.

External Applications

Kingspan KoolDuct[®] System ductwork can be installed in external applications however, like all insulation products, it is necessary to protect the factory applied facing from the adverse effects of sunlight and the weather. Please refer to the Project Specification section of this document for details.



Visible Applications

The *Kingspan KoolDuct*[®] System is aesthetically pleasing in open to view applications. Its availability in a black-coated facing makes it ideal for projects such as theatres, cinemas and nightclubs that require an unobtrusive air distribution solution.



Strength

Kingspan KoolDuct[®] System ductwork is very strong and is self supporting. *Kingspan KoolDuct*[®] rigid phenolic insulation panels are capable of being permanently formed to the required shape, and have sufficient strength to maintain their shape and duct integrity under operating conditions and limits defined in the Application Limitations & Recommendations section of this document on page 21. Larger sized ductwork and ductwork subjected to high pressures may require additional stiffening to avoid deflection.

Air Quality

The rigid phenolic insulation panels from which *Kingspan KoolDuct*[®] ductwork is fabricated, are resistant to fungal and mould growth, will not sustain vermin, are odourless, non-tainting and non-fibrous.

The air stream flowing through ductwork fabricated from the *Kingspan KoolDuct*[®] System flows over aluminium surfaces. It does not have any contact with a material that produces loose fibres which could be harmful, making it ideally suited for high specification projects. If sheet metal ductwork insulated with mineral fibre leaks air, loose fibres can get blown off the duct and into the general environment then into recirculation systems and back into the air handling system.

Cleaning

The *Kingspan KoolDuct*[®] System can be cleaned using many of the non-abrasive dry cleaning methods outlined in HVCA TR/19 (Guide to good practice. Internal cleanliness of ventilation systems, 2005), NADCA ACR 2006 (Assessment, Cleaning, and Restoration of HVAC Systems) and BS EN 13403: 2003 (Ventilation for Buildings. Non metallic ducts. Ductwork made from insulation ductboards). These include:

- compressed air / vacuum systems;
- hand wiping; and
- hand brushing.

System Benefits

Fabricated & Installed by Trained Contractors

Kingspan KoolDuct[®] System ductwork is fabricated and installed only by specially trained fabricators and installers, whose competence is continually monitored and controlled. Comprehensive training ensures uniform excellence. All registered fabricators and installers attend a specialised training program to ensure that uniform quality standards are maintained.

The course combines both theoretical and practical concepts:

- air flow dynamics, pressure and velocity;
- basic techniques in cutting and ductwork design;
- construction of a wide range of sizes and shapes;
- ductwork reinforcement, jointing and connection to sheet metal ductwork components and plant; and
- an introduction to project cost estimation.

The thumbnails below show the simple manual fabrication process required to create ductwork sections from the *Kingspan KoolDuct*[®] System.

Fabrication using the 4-bolt Flange



Fabrication using the Aluminium Grip Flange



Lifespan

Ductwork fabricated from the *Kingspan KoolDuct® System* will last as long as the life of the building in which it is installed. However, the lifespan of the ductwork is dependent upon the duct continuing to operate within the original design parameters, not being subjected to outside influences that may cause damage and being part of a regular maintenance programme.

Application Limitations & Recommendations

It is recommended that ductwork fabricated from the *Kingspan KoolDuct® System* be used for operation within the following limits:

Mean Air Velocity (Maximum)	20 m/s / 4000 fpm
Design Pressure (Maximum)	Positive: 1,000 Pa / 4 in.w.g. Negative: 750 Pa / 3 in.w.g.
Temperature (Maximum)	Internal air temperature of 80°C / 176°F during continuous operation
Size	Unlimited (provided that recommended <i>Kingspan KoolDuct® System</i> fabrication techniques and installation procedures are strictly observed)

Note: 'Mean Air Velocity' refers to the design air flow rate related to the cross sectional area of the ductwork.

Ductwork 'Pressure' relates to the total pressure of the relevant section of ductwork, and not the fan static pressure.

'Total Pressure' is a combination of both static and dynamic pressure.

The nature of ductwork fabricated from the *Kingspan KoolDuct® System* imposes certain limitations on its application, and it should not be used for the passage of solids or where it could potentially be damaged. It can be installed in an aggressive atmosphere provided that appropriate protective coatings are applied and certain precautions are followed. Kingspan Insulation Ltd should always be consulted for such applications. While the material has excellent fire and smoke performance, the material should not be used adjacent to high temperature sources or where the failure of control equipment may give rise to high temperatures. It is also important that combustible matter is not allowed to collect within the ductwork system, and accordingly, it is not recommended that the material be used in conjunction with kitchen extract and fume exhaust systems.

The *Kingspan KoolDuct® System* should not be used in the following applications:

- kitchen extract ductwork;
- conveyance of solids;
- conveyance of hot air with temperatures in excess of 80°C / 176°F;
- chemical, fume or smoke exhaust systems;
- with equipment of any type that does not include automatic maximum temperature controls; and
- adjacent to any mechanical / electrical source of extreme heat.

Although all components of the *Kingspan KoolDuct® System* have excellent erosion resistance characteristics, there may be a certain amount of dust remaining within the ductwork sections from the cutting and grooving operations during fabrication and assembly. It is therefore a procedural recommendation that the ductwork system is blown out prior to start-up.

Nevertheless, care must be taken to ensure that the ductwork system is cleaned to the appropriate level of cleanliness, particularly for applications in sensitive areas where a dust free and hygiene controlled environment is required such as operating theatres, clean rooms, hospitals, food manufacturing facilities, pharmaceuticals, etc.

Damage

The *Kingspan KoolDuct® System*, like any other material and equipment on site, may be at risk of physical damage, however, the *Kingspan KoolDuct® System* is surprisingly robust and serious damage is rare.

Research, by independent consultants Rider Levett Bucknall, has shown that where damage occurs, onsite construction activity is the primary cause. This is mainly due to the unfamiliarity of site operatives with the product, so it is often treated in the same manner as sheet metal material, with predictable results. The research, carried out in the UK, indicates that where operatives are made familiar with the product and / or specific measures are taken to identify the material and its properties, the risk of damage can be significantly reduced or eliminated.

However, the *Kingspan KoolDuct® System* offers the flexibility to repair localised damage in situ as opposed to replacing the entire ductwork section. Repairs can be made in an economical and efficient manner.

Product Data

Description

Kingspan KoolDuct[®] rigid phenolic insulation panels comprise a rigid phenolic insulation core faced on both sides with an extremely durable and protective low vapour permeability 25 micron / 1 mil aluminium foil reinforced with a 5 mm / 0.2" glass scrim. *Kingspan KoolDuct*[®] rigid phenolic insulation panels are also available with a 23 micron / 0.9 mil black-coated aluminium foil reinforced with a 5 mm / 0.2" glass scrim facing on one side and the above mentioned aluminium foil on the other.

Kingspan KoolDuct[®] rigid phenolic insulation panels are entirely CFC/HCFC-free with zero Ozone Depletion Potential (ODP).

Kingspan KoolDuct[®] rigid phenolic insulation panels are available in three thicknesses to suit different performance specifications:

- 22 mm / 7/8";
- 30 mm / 1 3/16"; and
- 33 mm / 1 5/16"

Heat Resistance

Kingspan KoolDuct[®] rigid phenolic insulation panels are suitable for use in peak temperatures as high as 80°C / 176°F and continuous operating temperatures up to 70°C / 158°F.

Moisture Resistance

Kingspan KoolDuct[®] rigid phenolic insulation panels have a 90% (or greater) closed cell structure, which means they are non-wicking and highly resistant to moisture penetration, and are particularly suitable for use in high relative humidity environments.

Thermal Performance

Immediately after manufacture, *Kingspan KoolDuct*[®] rigid phenolic insulation panels have a very low thermal conductivity which increases over a period of time as the insulation ages. The thermal conductivity then remains stable for the service life of the product.

The thermal conductivity of *Kingspan KoolDuct*[®] rigid phenolic insulation panels is 0.021 W/m·K / 0.146 Btu-in/hr-ft²·°F at 10°C / 50° F (mean), the lowest of any commonly available insulation material, allowing the thinnest possible insulation to achieve the required thermal performance and this is the value that should be used in all thermal calculations. The thermal resistances (R-value) of the different panel thicknesses are shown in the table below.

Thickness	R-value
22 mm / 7/8"	1.047 m ² ·K/W / 6.0 ft ² ·hr·°F/Btu
30 mm / 1 3/16"	1.428 m ² ·K/W / 8.1 ft ² ·hr·°F/Btu
33 mm / 1 5/16"	1.571 m ² ·K/W / 8.8 ft ² ·hr·°F/Btu

Environmental Performance

Kingspan KoolDuct[®] rigid phenolic insulation panels are manufactured without the use of CFCs/HCFCs and have zero Ozone Depletion Potential (ODP).



Kingspan Insulation has achieved BS EN ISO 14001: 2004 (Environmental management systems. Requirements with guidance for use),



which insists on year on year environmental improvements in the performance of any company that achieves the standard.

Fire & Smoke Performance

Kingspan KoolDuct[®] rigid phenolic insulation panels have a resistance to burning and spread of flame far superior to that of any other cellular plastic insulation. In addition, there is an almost complete absence of smoke when subjected to a flame source.

Kingspan KoolDuct[®] rigid phenolic insulation panels have been tested by independent laboratories. The tests shown in the table below have been successfully passed.

Standard	Description
BS 476-6: 1989	Fire tests on building materials and structures. Method of test for fire propagation for products
BS 476-7: 1997	Fire tests on building materials and structures. Method for classification of the surface spread of flame of products
BS 6401: 1983	Method for measurement, in the laboratory, of the specific optical density of smoke generated by materials
AS/NZS 1530-3: 1999	Methods for fire tests on building materials, components and structures – Simultaneous determination of ignitability, flame propagation, heat release and smoke release
ASTM E 84-08a	Standard Test Method for Surface Burning Characteristics of Building Materials
UL 723	Test for Surface Burning Characteristics of Building Materials
UL 181	Burning Test
Defence Standard 02-713	Determination of the Toxicity Index of the Products of Combustion from Small Specimens of Materials

Based on the results of the tests described above, *Kingspan KoolDuct*[®] rigid phenolic insulation panels:

- are classified as Class 0 to the Building Regulations in England & Wales, Northern Ireland and the Republic of Ireland, and Low Risk to the Building Standards in Scotland;
- meet the requirements of the fire hazard properties as set out in AS 4254: 2002 to comply with the Building Code of Australia (BCA) 2008 Specification C1.10-9;
- enable (as part of a comprehensive test program) the *Kingspan KoolDuct*[®] System to be UL Listed as a Class 1 Air Duct to Standard UL 181 in accordance with NFPA (National Fire Protection Association) Standards 90A & 90B; and
- are approved by the UAE Ministry of Interior Dubai Civil Defense for use in the fabrication of pre-insulated air distribution ductwork systems.

Quality Assurance

Kingspan KoolDuct[®] rigid phenolic insulation panels are manufactured to the highest quality standards under a quality control system approved to BS EN ISO 9001: 2000 (Quality management systems. Requirements).



Manufactured to BS EN ISO 9001: 2000
Certificate No. 388

Health & Safety

Kingspan Insulation products are chemically inert and safe to use. A leaflet (Material Safety Data Sheet) on this topic is available from the *Kingspan* Insulation Marketing Department (see rear cover):

Note that the reflective surface on this product is designed to enhance its thermal performance. As such, it will reflect light as well as heat, including ultraviolet light. Therefore, if this board is being installed during very bright or sunny weather, it is advisable to wear UVA & UVB protective sunglasses or goggles, and if the skin is exposed for a significant period of time, to protect the bare skin with a UVA & UVB block sun cream.

The reflective facing used on this product can be slippery underfoot when wet. Therefore, it is recommended that any excess material should be contained to avoid a slip hazard.

Warning – do not stand on or otherwise support your weight on this board unless it is fully supported by a load bearing surface.

Issues to Consider

Whole Life Costs

Summary

The *Kingspan KoolDuct*® System must be considered as the product of choice for HVAC ductwork systems in projects where 'whole life' costing is a requirement since:

- installation of the *Kingspan KoolDuct*® System can save over 21% on capital cost; and
- over a 30 year life cycle, the *Kingspan KoolDuct*® System can also make a saving of over 20% on operating costs.

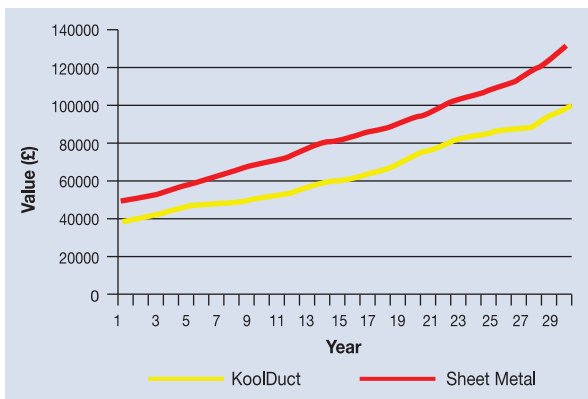

Introduction

In the construction industry, developers, funding bodies and manufacturers have historically focused on achieving a low capital cost in order to improve profits.

However, for buildings that are let / rented out under contracts which include ongoing maintenance and services provision by the lessor, or for buildings developed for forward thinking clients, operating cost can be as just important as capital cost in building design.

'Whole life' costing takes account of the total cost of an item over its life, including durability, energy savings and maintenance, as well as initial purchase price.

Review of the Alternatives

Kingspan Insulation commissioned independent consultants, Cyril Sweett, to carry out an analysis of the 'whole life' costs of differing UK HVAC ductwork specifications*. Cyril Sweett's initial work narrowed the analysis of 'whole life' cost down to costs associated with installation, durability, energy use, cleaning, risk of mechanical damage and damage repair; the findings of which are described herein.

The installed cost of ductwork fabricated from the *Kingspan KoolDuct*® System was found to be cheaper than that of galvanised sheet steel ductwork.

Cyril Sweett concluded that *Kingspan KoolDuct*® rigid phenolic insulation panels consist of a densely cross linked structure which does not readily break down. They also noted that independent testing has shown that the thermal performance of Kingspan Insulation rigid phenolic insulation panels are not prone to long term degradation and that they maintain their designed performance throughout a 'whole life' 30 year period.

Cyril Sweett endorsed the contents of a study carried out by independent consultants Rider Levett Bucknall, based on the results of research carried out by BSRIA, to investigate the estimated effect on fan power of different duct air leakage rates. The research showed that the *Kingspan KoolDuct*® System can save over 30% on the annual electricity cost of running a fan compared with the performance of galvanised sheet steel ductwork.

Cyril Sweett's research showed that ductwork fabricated from the *Kingspan KoolDuct*® System is marginally more expensive to clean than galvanised sheet steel ductwork.

Cyril Sweett's own research into ductwork maintenance showed that ductwork fabricated from the *Kingspan KoolDuct*® System suffers minimal damage and thus requires minimal repairs, particularly where ductwork is installed within a ceiling void. In circumstances where a repair is required, it concluded that ductwork fabricated from the *Kingspan KoolDuct*® System can be repaired quickly by simply replacing the damaged area whereas with sheet metal ductwork, the entire section would need to be replaced, with the insulation installed as a second operation.

Once the above data had been analysed, the capital, operating and 'whole life' costs were calculated.



Results of the Analysis

Cyril Sweett based the comparison of capital cost on a system comprising 308 m / 1010 ft of ductwork of a wide variety of dimensions.

The capital cost of insulated galvanised sheet steel ductwork was £47,154 versus £37,000 for ductwork fabricated from the *Kingspan KoolDuct® System*.

Thus, the *Kingspan KoolDuct® System* can provide a capital cost saving of 21.5% (see the table below).

Cyril Sweett then calculated the operating cost of the two technologies over a 30 year period, taking into account energy use, maintenance, cleaning and changes due to wear and tear (churn).

Over a 30 year period, the system operating cost for insulated galvanised sheet steel technology was £85,058 versus £67,672 for the *Kingspan KoolDuct® System*. Thus, the *Kingspan KoolDuct® System* can provide an operating cost saving of 20% (see the table below).

Combining capital and operating costs to give a 'whole life' cost yields a total saving of £27,540. Thus the *Kingspan KoolDuct® System* can provide an overall 'whole life' cost saving of 21%.

Technology	<i>Kingspan KoolDuct®</i>	Insulated Galvanised Sheet Steel
Capital Cost (£)	37,000	47,154
Saving (%)	21.5	
Operating Cost (£) (Over 30 yrs)	67,672	85,058
Saving (%)	20.4	
'Whole Life' Cost (£)	104,672	132,212
'Whole Life' Saving (%)	20.8	

Note the costs detailed in this report are based on the use of the Kingspan KoolDuct® System constructed with 22 mm / 7/8" rigid phenolic insulation panels and the aluminium grip flange jointing system versus 40 mm / 1 1/2" mineral fibre insulated galvanised sheet steel ductwork.

**A copy of the Cyril Sweett Limited report is available upon request from the Kingspan Insulation Marketing Department on +44 (0) 870 733 8333.*

Economy of Duct Design

A ductwork system accounts for a substantial portion of the overall cost of a building's HVAC system – potentially in excess of a third of the total cost. Careful and attentive planning during the design stage of a ductwork system can yield a significant reduction in its overall cost.

There are two factors in particular that can have a considerable impact:

- the total number of special pieces / fittings (pieces other than straight sections); and
- the aspect ratio of the ductwork sections.

Special pieces / fittings such as elbows, reducers, and offsets, etc. require considerably more labour (and material to a certain extent) to construct than straight sections. While all ductwork systems will require a certain quantity of special fittings, their usage should be minimised. Ideally, the system should follow the straightest possible route.

The other point which is less intuitively obvious is the aspect ratio of ductwork sections. This ratio is defined as the length of a section of ductwork's longer side divided by its shorter side. As the aspect ratio increases, the corresponding surface area increases dramatically. The graph below illustrates this relationship for six duct sizes of identical cross sectional area with different aspect ratios. In addition, higher aspect ratio ducts also exhibit increased frictional resistance and noise. As can be seen, a square aspect ratio (1:1) is the most economical.

However, while smaller aspect ratios are more desirable from a material requirement and aerodynamic standpoint, the trade-off is in space utilisation, as small aspect ratio ducts require more clearance for installation. Based on all of these considerations, it is not recommended that aspect ratios exceed 4:1.

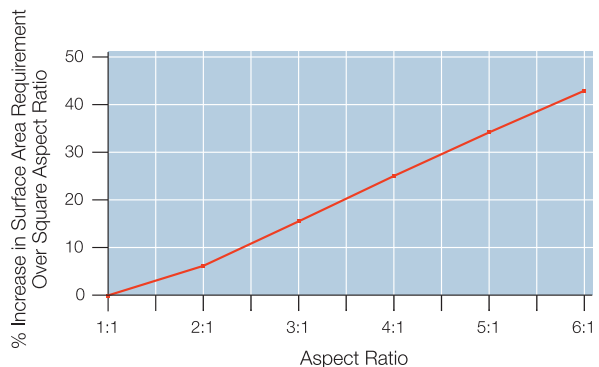

Issues to Consider

Weight

Summary

- The introduction of the *Kingspan KoolDuct*[®] System to a project can save money and add value.
- The System provides the only practicable solution for some projects.
- The System can function to ensure project viability.
- For the above reasons, the *Kingspan KoolDuct*[®] System should be an automatic consideration for refurbishment projects.

Current Practice

- HVAC systems are commonly added to built environments which have not previously incorporated such systems.
- Existing building structures commonly have insufficient load capacities for new service loads.
- HVAC ductwork is traditionally constructed using galvanised sheet steel insulated with mineral fibre, which is installed as a separate construction activity.
- Time constraints mean that projects may start before the design process is complete.
- The ductwork material is commonly not considered until late in a project's design process.
- Those who are not intimate with a project's constraints commonly select the ductwork material.
- Detailed surveys of existing structures to the level required to plan service layouts are commonly unavailable before construction commences.
- Services design and design co-ordination commonly occurs concurrently with the construction process, often requiring significant changes to the ductwork configuration.
- Delays are commonly caused by unforeseen obstacles discovered only once construction starts and full exposure of the structure occurs.
- Delays are commonly caused by design changes that are required during the construction period.

Review of the Alternatives

Kingspan Insulation commissioned an independent review of six UK case studies by independent consultants, Rider Levett Bucknall*. The purpose of this review was to examine insulated sheet steel ductwork and the *Kingspan KoolDuct*[®] System, their relative performance with regards to weight and the benefits that this can incur.

A series of refurbishment or fit out projects that used the *Kingspan KoolDuct*[®] System were reviewed. Data was collected by interviewing personnel involved, including the project managers, architects, structural engineers, services engineers and quantity surveyors, contractors, services sub-contractors and ductwork sub-sub-contractors.

Almost without exception, the light weight of the *Kingspan KoolDuct*[®] System had an impact on the project, contributing to its success through a reduction of the potential project cost or by directly influencing its feasibility.

In some instances, the *Kingspan KoolDuct*[®] System had been selected at the outset because of its known properties and the project constraints. Generally however, it was not an initially specified choice but was subsequently selected to overcome problems that arose during the development of the detailed design.



Cadogan Hall, Sloane Square, London

The loadings imposed by the new theatre ventilation system were minimised with the *Kingspan KoolDuct*[®] System, removing the need for additional support members, which would have been difficult to install within the existing historic structural element.



Virgin Roof Gardens, Kensington, London

The light weight of the *Kingspan KoolDuct*[®] System enabled the new extension structure to accommodate the load of the existing structure in addition to the considerable network of ductwork, eliminating the need for a substantial redesign.

The explanation for this is that, for historical reasons, the majority of ductwork in the UK construction industry is fabricated using galvanised sheet steel with the insulation subsequently installed, if required. The selection of ductwork material is therefore generally assumed. Additionally, the construction project client's specification for ductwork is normally limited to a set of performance criteria rather than a specific material. The actual selection of the ductwork material is made by the mechanical services sub-contractor or, more often, its ductwork sub-sub-contractor. Neither of these organisations derives a direct benefit from the selection of the **Kingspan KoolDuct® System**. Indeed, because of existing manufacturing setups, it may be disadvantageous to move away from the existing specification norms. With the material selection so far removed from those dealing with the specific project constraints, it is not surprising that the selection of the most appropriate material often occurs well into the design process or, to the client's disadvantage, not at all.

On the reviewed projects, the main reason for the selection of the **Kingspan KoolDuct® System** was that it could overcome severe constraints on structural loadings. In these circumstances, the selection of the **Kingspan KoolDuct® System**, over a galvanised sheet steel ductwork system, was often the only realistic choice, the alternative normally being the introduction, at potentially significant additional cost, of secondary steel supports to transfer service loads back to the structure. In some projects, even this option was not available for example, where buildings contained features of historic or architectural importance that could not be obscured by the introduction of new structural members.

An additional attribute contributing to the selection of the **Kingspan KoolDuct® System** was its ability to be delivered to site in a flat form and for the ductwork sections to be assembled onsite or even, in extreme situations, in their final locations. For sites with extreme space constraints, this characteristic became crucial to the success of the project. The pre-insulated nature of the **Kingspan KoolDuct® System** also removed the need for access space required for the subsequent insulation installation, which proved to be another valuable advantage in the constrained environment of existing buildings.

The flexibility of being able to fabricate the ductwork onsite also proved advantageous in rapidly dealing with unexpected changes to the design required by the uncovering of unforeseen obstructions, or as a result of other design amendments. This feature played an important part in enabling contract programmes to be maintained whereby the replacement of fabricated and delivered galvanised sheet steel ductwork would have taken 2–3 weeks.

In all situations, the lightweight nature of the **Kingspan KoolDuct® System** made the installation process easier. A further, more direct result of the lightweight properties was that the material had a greatly reduced hazard potential. Risk assessments, required for construction operations, were less onerous than those associated with installing the far heavier alternative materials and hence the safety strategies and protection measures that were adopted were also less onerous.

*A copy of the Rider Levett Bucknall report is available upon request from the Kingspan Insulation Marketing Department on +44 (0) 870 733 8333.



Lloyds No.1 Bar, Chichester
The **Kingspan KoolDuct® System** purged the need for the probable introduction of secondary steel supports in this existing single storey steel frame structure, for the new suspended ceiling and major ductwork serving the new services installation.



Crawford Theatre, University of Strathclyde, Scotland
The roof was prohibited from being subjected to additional loading. The use of the **Kingspan KoolDuct® System** reduced the overall service loading, and the consequent design strength (and hence cost) of the steel support system.

Issues to Consider

Installation Speed

Summary

- The *Kingspan KoolDuct*[®] System can be installed up to three times faster than sheet metal ductwork.
- Construction periods can be reduced where ductwork is a critical path activity.
- The risk and extent of time extensions on projects can be reduced.
- For the above reasons, the *Kingspan KoolDuct*[®] System should be an automatic consideration where project durations are a key issue and ductwork is a critical path activity.

Current Practice

- HVAC systems are a common feature of both new build and refurbishment construction works.
- HVAC ductwork is traditionally constructed using galvanised sheet steel insulated with mineral fibre, which is installed as a separate construction activity.
- The ductwork material is commonly not considered until late in a project's design process.
- Those who are not intimate with a project's constraints commonly select the ductwork material.
- Services design and design co-ordination commonly occurs concurrently with the construction process, often requiring significant changes to the ductwork configuration.
- Ductwork is not normally considered as an area of programme risk or where there is scope for improvement in activity duration.
- Delays are commonly caused by unforeseen obstacles discovered only once construction starts and full exposure of the structure occurs.
- Delays are commonly caused by design changes that are required during the construction period.

Review of the Alternatives

Kingspan Insulation commissioned an independent review of six UK case studies by independent consultants, Rider Levett Bucknall*. The purpose of this review was to examine insulated sheet metal ductwork and the *Kingspan KoolDuct*[®] System, their relative performance with regards to speed of installation and the benefits that this can incur.

Data was collected by interviewing personnel involved including the project managers, architects, structural engineers, services engineers and quantity surveyors, contractors, services sub-contractors and ductwork sub-sub-contractors.

A series of interviews were also undertaken with main contracting organisations, to review how the ductwork installation activity generally fitted within the overall construction programme and its interaction with preceding, concurrent and succeeding activities.

In the UK, the *Kingspan KoolDuct*[®] System can be constructed in ductwork sections up to 3 m / 10 ft long, provided the cross sectional dimensions of the duct are less than 1.2 m / 3.94 ft. More importantly, because of its comparative light weight, several sections can be jointed together on the floor level and installed in a single operation. It was commonly found that lengths of up to 9 m / 30 ft were assembled and installed in this manner, with instances where the total length raised in one operation was up to 15 m / 50 ft long.

Ductwork installers reported that *Kingspan KoolDuct*[®] System ductwork could be installed at an average of three times the rate of equivalent sheet metal ductwork. Although every scheme will be different and there are rarely exactly comparable circumstances, the average installation productivity for a two-man team is 7–9 m/day / 23–30 ft/day for sheet metal ductwork, and 23–25 m/day / 75–82 ft/day for *Kingspan KoolDuct*[®] System ductwork. These figures exclude the time required to install the ductwork insulation to sheet metal ductwork; a process not required by the *Kingspan KoolDuct*[®] System of pre-insulated ductwork.



House of Fraser, King William Street, London

The ability to fabricate *Kingspan KoolDuct*[®] ductwork onsite proved invaluable when unknown obstructions were revealed. The extensive amounts and critical nature of the ductwork installation meant that the faster installation speed saved weeks on the programme.



Chelsea Bridge, Wharf, London

At three times the planned productivity, the installers were able to achieve installations to 10–12 apartments per day. The ductwork had been a critical path activity but the installation speed was so much faster than planned that it came off the critical path.

Where the projects involved a significant amount of air handling ductwork, the period of time during which the activity was critical could be significant, and the introduction of the **Kingspan KoolDuct® System** can operate to reduce project durations by several weeks. If the project is restricted to the simple refurbishment, replacement or retro fitting of an air handling / ventilation system then the full advantage of the faster installation speed can be available.

However, for most projects incorporating industry standard fan coil air conditioning systems, the ductwork remains on the critical path for only a short period of time. On these projects the research indicated that pipework and its insulation normally proves to be the limiting factor, preventing maximum advantage of the **Kingspan KoolDuct® System's** faster installation times.

The faster installation speeds were achieved with the same level of resources as sheet metal ductwork. This helped to create a lower density of site labour for ductwork installation, and thus increased the efficiency and productivity for other trades and activities by reducing pressure on space and site facilities. This advantage was further enhanced by removing the requirement for an insulation activity and its associated labour.

The faster installation speeds permitted consideration to be given to re-sequencing other work activities to allow for more economic and less disruptive work practices. On at least two projects, this approach allowed the internal partitions to be constructed around the ductwork rather than cutting holes through the completed elements of the new structure.

The flexibility of being able to fabricate the ductwork onsite also proved advantageous in rapidly dealing with unexpected changes to the design required by the uncovering of unforeseen obstructions, or as a result of other design amendments. This feature played an important part in enabling contract programmes to be maintained whereby the replacement of fabricated and delivered galvanised sheet steel ductwork would have taken 2–3 weeks.

In some instances the **Kingspan KoolDuct® System** had been selected at the outset because of its known properties and the project constraints. Generally however, it was not an initially specified choice but was subsequently selected to overcome problems that arose during the development of the detailed design.

In summary, the majority of the individuals interviewed stated that the **Kingspan KoolDuct® System** had an impact on the programme of the projects on which they were involved. The savings were in the form of shorter initial contract durations and / or reductions in, or removal of the need to extend contract periods as a result of design developments and variations arising during the construction period.

Due to the confidential nature of financial and programming information, together with the wide variety of project types that were reviewed, it is not possible to provide a simple answer to the question regarding the amount of the monetary savings available. Based on the projects reviewed the savings could range from £5,000–£50,000. In no instance was it found that the introduction of the **Kingspan KoolDuct® System** resulted in a potential increase in the contract value.

*A copy of the Rider Levett Bucknall report is available upon request from the Kingspan Insulation Marketing Department on +44 (0) 870 733 8333.



Calcutta House, Oldgate East, London

The **Kingspan KoolDuct® System** provided a solution that helped to achieve a very short contract period in the refurbishment of this existing building, and the need for the flexibility to adapt the ductwork to existing structural constraints.



Matalan, Knaresborough, UK

In the constrained working environment the delivery of processed **Kingspan KoolDuct®** panels, delivered flat and effectively assembled and installed in position, provided a speedier solution, which reduced the trading impact.

Issues to Consider

Energy & Running Costs

Summary

- The use of the *Kingspan KoolDuct® System* can save over 30% of the energy required to run a fan in an HVAC system.
- Its use can reduce the size of fan required in a HVAC system – this reduction in fan size can yield a 10% saving in its capital cost.
- For the above reasons, the *Kingspan KoolDuct® System* should be an automatic consideration for all HVAC ductwork specifications.



Current Practice

- HVAC ductwork systems are a common feature of new build and refurbishment construction works.
- HVAC ductwork is traditionally constructed using galvanised sheet steel insulated with mineral fibre which is installed as a separate construction activity.
- The ductwork material is commonly not considered until late in a project's design process.
- Little or no attention is paid to the effects that ductwork air leakage has on fan energy use and carbon dioxide emissions.
- Little or no attention is paid to the potential for downsizing fans and reducing capital costs on the back of lower ductwork air leakage rates.

Review of the Alternatives

The sealing methods used in the construction of *Kingspan KoolDuct® System* ductwork sections and the jointing systems used to connect them, lead to the creation of comparatively very airtight ductwork systems. Class 3 (SMACNA) and Class C (HVCA DW/144, BS EN 13403: 2003 and BS EN 1507: 2006) air leakage performance can be readily obtained using the *Kingspan KoolDuct® System*. This low air leakage is known to have an impact on the energy consumption of the fan delivering the air into the ductwork system.

Kingspan Insulation commissioned a review*, by independent consultants BSRIA, of the implication of ductwork specification and different duct air leakage rates on energy consumption. The methodology given in the BSRIA report was used to compare a 100 m / 328 ft long run of galvanised sheet steel ductwork and a 100 m / 328 ft long run of the *Kingspan KoolDuct® System*. Both runs of ductwork had cross sectional internal dimensions of 600 mm x 600 mm / 1.97 ft x 1.97 ft. The results are shown in the table below.

Velocity (m/s / fpm)	Cross Sectional Area (m ² / sq.ft)	Flow Rate (l/s / cfm)	Flow Rate Plus Galv. Sheet Steel Ductwork Leakage (l/s / cfm)	Flow Rate Plus KoolDuct® Leakage (l/s / cfm)	Reduction in Flow Rate (%)	Reduction in Fan Power (%)
5 / 1000	0.36 / 3.88	1800 / 3814	2168.05 / 4593.84	1811.04 / 3837.37	16.5	41.7
7.5 / 1500	0.36 / 3.88	2700 / 5720	3068.05 / 6500.83	2711.04 / 5744.37	11.6	31.0
10 / 2000	0.36 / 3.88	3600 / 7628	3968.05 / 8408.05	3611.04 / 7651.36	9.0	24.6

BSRIA's methodology demonstrated that the *Kingspan KoolDuct® System* can save 31% of the energy required to run a fan in a HVAC system with a typical design flow rate of 7.5 m/s / 1500 fpm. These savings can be greater for lower design flow rates.

Kingspan Insulation commissioned a review*, by independent consultants Rider Levett Bucknall, of the implications of reduced fan power on actual energy usage.

Rider Levett Bucknall concluded that for a 100 m / 328 ft long run of ductwork, with cross sectional internal dimensions of 600 mm x 600 mm / 1.97 ft x 1.97 ft and an air velocity of 7.5 m/s / 1500 fpm, the *Kingspan KoolDuct® System* could save 3,100 kW.hr / 10.58×10^6 Btu per annum.

This energy saving equates to a saving of 1.3 metric tonnes / 1.28 long tons of CO₂ equivalent emissions per annum.

Kingspan Insulation commissioned a further review*, by Rider Levett Bucknall, of the implications of reduced fan power on fan size and capital cost. Their conclusions are shown below.

Typically a fan will be sized on the amount of air that is needed to deliver the required volume of air, taking into account pressure drop. A multiplier (normally 10%) will then be applied, to take into account the flexibility required due to the actual resistance and final installation. If the system does not leak as much as is permitted under the air leakage tests (which are maximum figures,) then the fan is commissioned to run at a lower speed by using inverter drives or belt and pulley changes.

Air leakage directly relates to the size of the fan required to deliver the designed air flow in a duct. The *Kingspan KoolDuct® System* has a lower leakage rate than galvanised sheet steel ductwork – 11.6% lower for a 100 m / 328 ft long run of ductwork with cross sectional internal dimensions of 600 mm x 600 mm / 1.97 ft x 1.97 ft and an air velocity of 7.5 m/s / 1500 fpm (refer to the table on the previous page). Therefore, by using the *Kingspan KoolDuct® System* in lieu of a galvanised sheet steel ductwork system, an 11.6% reduction in fan size could be achieved for a duct of this size and velocity.

A duct with these characteristics would typically convey approximately 2.5 m³/s / 5297 cfm of air (at a standard atmospheric pressure and temperature as per CIBSE guide, Clause 4.2) possibly serving a minimum fresh air fan coil unit system.

For a comparable system using the *Kingspan KoolDuct® System* as the ductwork specification, an 11.6% reduction on the size of the fan is achievable due to the lower air leakage rate therefore the fan duty, for the *Kingspan KoolDuct® System*, would be 2.2 m³/s / 4662 cfm.

The respective costs in GBP (£) of a supply air fan within an air handling unit for the two systems are:

- Galvanised Sheet Steel Ductwork (2.5 m³/s / 5297 cfm)
£2000
- *Kingspan KoolDuct® System* ductwork (2.2 m³/s / 4662 cfm)
£1800

This equates to an approximate capital cost saving of 10%.

NB the energy and capital costs included in this paper are based on test results carried out on a 100 m / 328 ft long straight piece of ductwork. In practice, air leakage is more likely to occur where ductwork changes direction and therefore we suggest that leakage tests are carried out on an installed system to ratify the findings of this study. Secondly, in order to achieve the fan energy and capital costs that are available, current engineering practice needs to be reviewed.

*Copies of the CIBSE and Rider Levett Bucknall reports are available upon request from the Kingspan Insulation Marketing Department on +44 (0) 870 733 8333.

Issues to Consider

Moisture & Exacerbated Heat Loss / Gain



The measure of the rate at which heat flows through an insulant is known as its thermal conductivity or k-value. The lower the k-value, the better the insulant is at restricting heat flow.

Kingspan KoolDuct® rigid phenolic insulation panels have a k-value of 0.021 W/m·K at 10°C mean / 0.146 Btu·in/ft²·hr·°F at 50°F mean, which offers the best performance of all commonly utilised insulating materials.

The k-value for an insulant is measured with the material under laboratory conditions. In-service applications rarely if ever replicate these conditions and it is therefore important to consider physical factors which may alter this state and lead to an increase in the k-value of the material and thus increased primary energy usage.

The k-values of commonly used insulants typically lie in the range of 0.021 to 0.046 W/m·K at 10°C / 0.146 Btu·in/ft²·hr·°F to 0.319 Btu·in/ft²·hr·°F at 50°F mean. These measurements relate to the material at a specific temperature and in a dry state. If moisture is introduced into the insulant, the measured conductivity will increase very significantly. If moisture is able to penetrate to the point of saturation or near saturation, the thermal efficiency of the insulant can be destroyed. This is due to three main mechanisms:

- the k-value of water is 0.58 W/m·K at 10°C / 4.03 Btu·in/ft²·hr·°F at 50°F, which is significantly higher than that of all commonly used insulants – thus if moisture is present the overall thermal conductivity of the material will increase significantly depending on the quantity of water absorbed;
- moisture moving through or within an insulant can effectively absorb heat from the warm side and then dissipate it on the cold side of the assembly; and
- a closed assembly in which moisture is trapped within the insulant between impermeable layers (such as with aluminium foil faced duct insulation) can be subject to additional ‘phase change’ heat losses.

These heat losses occur when heat from the warm side of the insulant vapourises the trapped moisture which then diffuses through the insulant to the cold side. When it reaches the cold side the heat is dissipated, the vapour condenses back into liquid form and flows back to the warm side of the insulation. This is a closed cycle which could theoretically continue indefinitely if acceptable environmental conditions prevail and leads to significant additional heat losses through the insulant.

Moisture can be present in insulation due to:

- penetration through the weather protection; and
- vapour penetration through the vapour barrier jacket leading to interstitial condensation on below ambient ductwork, particularly in tropical climates where conditions are warm and wet on the outside and cold and dry on the inside of the ductwork.

Mineral fibre has little resistance to water vapour penetration which may occur if it is installed with an imperfectly sealed vapour barrier jacket or if the vapour barrier jacket is damaged in use. This can result in:

- condensation formation on below ambient temperature ductwork;
- corroded ductwork;
- dripping services and spoiled ceilings;
- mould growth and bad odour;
- building fabric damage;
- increased energy consumption; and
- expensive repair works causing disruption to business.

Different types of insulant absorb differing levels of moisture. The level of moisture absorbed also affects varying types of insulants in different ways. Whilst closed cell materials, e.g. *Kingspan KoolDuct*[®] rigid phenolic insulation panels, may have low water vapour permeability characteristics, fibrous insulating materials can absorb considerable quantities of water which, whilst present can adversely affect the thermal conductivity and the effectiveness of the insulation.

Since rigid phenolic insulation has a 90% (or greater) closed cell content, moisture is not readily absorbed as it must penetrate through the cell walls to enter the material. This does not readily occur unless the cell walls have been damaged. If it does occur, the amount of moisture absorption is generally very low and is effectively eliminated if the insulant is faced with an impervious material such as aluminium foil.

If moisture is able to penetrate the outer damaged cells of rigid phenolic insulation where there is no impervious facing material, it will increase the overall thermal conductivity of the product slightly. However, it will not lead to any long term degradation of the product and will fully dry out once favourable environmental conditions exist.

Kingspan KoolDuct[®] rigid phenolic insulation panels have an aluminium foil facing on both sides which makes them highly resistant to moisture penetration.

The risk of moisture penetration from damage to the aluminium foil vapour barrier jacket is considerably reduced as the rigid phenolic insulation core of the *Kingspan KoolDuct*[®] panels is of 'closed cell' construction.

Vapour seal tape can be easier to apply to *Kingspan KoolDuct*[®] rigid phenolic insulation panels with a more secure and efficient seal.

Mineral fibre insulants are open structured materials which rely largely on entrapped still air for much of their insulating power. They can have little long term resistance to water and may have no resistance to vapour flow. Thus, the potential for moisture absorption can be very high if the factory applied vapour barrier jacket is either damaged or inadequately sealed.

Research has been undertaken into the effect of moisture of mineral fibre insulants by Achtziger and Cammerer of FIW in Germany. Their research concluded that 1% moisture content by volume within mineral fibre can increase the thermal conductivity of the material by 36–107% with 4 of the 5 samples tested falling within the 95–107% increase range (Forschungsvorhaben Nr.815–80.01.83–4 contained within CEN TC 88 WG 4–N484). Such increases in the thermal conductivity of the material could have a very significant impact on the level of heat loss or gain on a building services installation.

Issues to Consider

Sustainability

In the past, erroneously, the relative environmental sustainability of insulation materials has been compared on the basis of embodied energy and ozone depletion potential. It is now recognised that a much wider basket of embodied environmental impacts (including those caused by their embodied energy), rather than embodied energy alone, is the only credible tool of comparison. Time has also annulled ozone depletion potential as an issue, for example in the EU, all insulation materials are now banned from using CFCs and HCFCs.

For buildings designed to today's energy use requirements it is now also known that the embodied environmental impacts of all of the materials and labour used to create a building are insignificant in comparison with the lifetime operational environmental impacts of that building and so are of very limited importance. Since it is operational energy use that creates the vast majority of operational environmental impact, saving energy by specifying the lowest heat loss / gain and ductwork air-leakage standards possible is the most environmentally sustainable action to take. A ground breaking study "Insulation for Environmental Sustainability" has been published by BING on this and related issues. This report, written by XCO2 connisbee, is freely available from Kingspan Insulation (see rear cover).



Furthermore, one of the most neglected facts about environmentally sustainable buildings is that the longevity of their standards of operational energy use, and therefore the longevity their operational environmental impacts, is critical. The performance of some insulants, such as mineral fibre, can deteriorate rapidly if exposed to water penetration, air movement or compression. This may increase operational energy use and hence compromise the environmental sustainability of the finished building to an alarming degree. Other insulation materials, such as rigid phenolic insulation are considerably less vulnerable to any of these problems than mineral fibre.

In summary, designers should:

- (a) specify the best heat loss / gain and ductwork air leakage standards possible, regardless of insulation / ductwork type;
- (b) design out the risk of their chosen insulant / ductwork system not performing as specified; and
- (c) if the latter is not possible, choose an insulant / ductwork system that is at low risk of failure e.g. rigid phenolic pre-insulated ductwork.

The *Kingspan KoolDuct*[®] System is therefore arguably the most environmentally sustainable ducting technology available.

However, manufacturers should not rest on their laurels, it is a matter of social responsibility to be open and honest about the environmental impact of the manufacture of a product, and a full Life Cycle Analysis (LCA) based on a much wider basket of environmental impacts, rather than embodied energy alone, is recognised as the preferred tool to achieve this.

Kingspan Insulation was the first insulation manufacturer to complete and openly publish an independently certified Ecoprofile (a type of LCA) on one of its product ranges. This was carried out by the Building Research Establishment (BRE). Kingspan Insulation is currently completing a BRE Ecoprofile of its rigid phenolic insulation products, including *Kingspan KoolDuct*[®] rigid phenolic insulation panels.

But there is far more to sustainability than whether or not a product, process or company affects the environment in a positive or a negative way. A company can and should demonstrate its financial viability and social responsibility, as well as ensure that its materials and methods do not add unduly to the burden placed on the planet.

In 2004 Kingspan Insulation put the manufacture of its products at its Pembridge, Herefordshire facility in the UK through a rigorous independent appraisal of its economic, social, environmental and natural resource impacts using Arup's SPeAR[®] tool. These products include *Kingspan KoolDuct*[®] rigid phenolic insulation panels.



CERTIFIED



SPeAR®

ARUP

2004 Appraisal

The results showed a well balanced performance in terms of sustainability, and that Kingspan Insulation is already meeting legislation or best practice in most areas, even moving beyond best practice in some.

Arup's report details the recommendations and the actions that Kingspan Insulation committed to take as a result of Arup's analysis.

A year later 2005 and then again in 2006 and 2007, Arup returned to the Pembroke site to audit Kingspan Insulation's progress.

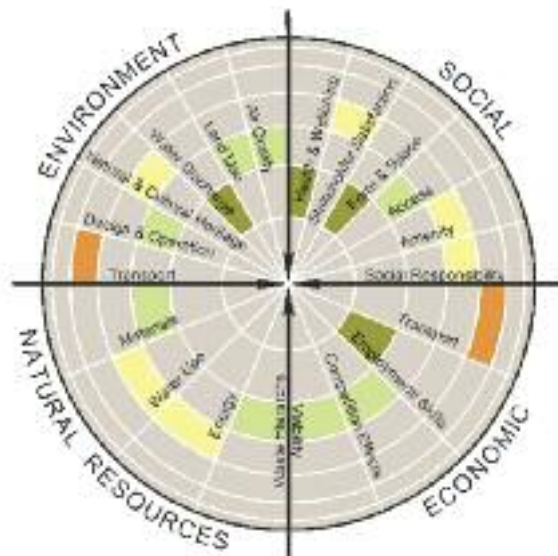

CERTIFIED



SPeAR®

ARUP

2007 Appraisal

The results showed a substantial improvement across all four sections of the Arup SPeAR diagram. Arup will audit the site again in 2009.

Kingspan Insulation was the first construction material manufacturer in the UK to take this bold step and openly publish the results.

Contact the Kingspan Insulation Marketing Department for a copy of the publication that contains, in full, Arup's 2005 and 2006 Assessment reports and Kingspan Insulation's 2007 action plan (see rear cover).



Issues to Consider

Embodied Energy



It is often claimed by mineral fibre manufacturers that the embodied energy of their products is lower than that of alternative materials such as the rigid phenolic insulation panels that make up the *Kingspan KoolDuct® System*.

Embodied energy is a measure of the total amount of energy consumed by a product during production and installation. It includes the energy used during the extraction of raw materials, transportation, manufacture through to the installation of the product.

The lower the embodied energy of an insulating product, the lower its overall environmental impact and the faster its environmental payback will be. The environmental payback for an insulating product occurs when it has effectively conserved more energy by restricting heat loss or gain, than its initial embodied energy figure.

In the case of insulating products in energy saving applications the environmental payback period is generally extremely short, compared with the lifetime of the application. After the environmental payback is complete, the insulating products can go on saving energy for many years more. Because of this, the energy saved over the lifetime of an application is mostly far greater than the embodied energy of the insulating products saving that energy. Embodied energy is therefore usually irrelevant in the specification of insulating products.

However, even though mineral fibre manufacturers are aware of this, they persist in using embodied energy as a platform to promote their products.

The embodied energy content of mineral fibre and rigid phenolic insulants vary significantly. Some mineral fibre insulants have been quoted as having an embodied energy content of 13–26 MJ/kg whilst rigid phenolic insulation is quoted as having an embodied content of 100 MJ/kg. Whilst these figures would seem to suggest that the mineral fibre insulant is the more environmentally friendly product, as it has the lower energy content per kilogram, this is not the case.

In comparing the embodied energies of materials, the concept of a functional unit must be taken into account. In the case of ductwork insulation, the functional unit depends upon firstly, the density of the insulation and secondly, the thickness of insulation required to achieve a defined heat loss / gain. This thickness will vary depending upon the thermal conductivity of the insulation material.

If a comparison is to be made between the *Kingspan KoolDuct® System* and conventional galvanised sheet steel ductwork insulated with different materials, then the functional unit must not only include the insulation as specified above, but also, in the case of conventional ductwork, the sheet metal as it is absent from the *Kingspan KoolDuct® System*.

The results of such a comparison between a 1.25 m x 0.8 m / 49" x 32" ductwork section fabricated from the *Kingspan KoolDuct® System* and conventional galvanised sheet steel ductwork section insulated with mineral fibre are shown below. The insulation thicknesses in this comparison are taken from:

- the TIMSA Guide (see the Project Specification – Appendix A2 section of this document for details);
- the BCA 2008 Specification J5.2–3 Table 3b (see the Project Specification – Appendix B2 section of this document for details);
- BS 5422: 2001 (see the Project Specification – Appendix C2 section of this document for details); and
- ANSI / ASHRAE / IESNA 90.1: 2007 (see the Project Specification – Appendix D2 section of this document for details).

If both the mineral fibre (embodied energy estimated at 21 MJ/kg) and phenolic (density 60 kg/m³ – embodied energy 100 MJ/kg) products were finished with an aluminium foil facing (embodied energy estimated at 52.5 MJ/m²) the embodied energy content of the insulated ducts would be as shown in the table below. In the cases of mineral fibre, these figures take account of 1.0 mm / 20 Gauge galvanised sheet steel ducting (density 7842 kg/m³ / 490 pcf – embodied energy 32.5 MJ/kg) and assume the above-stated aluminium foil finish for the inside surfaces of the *Kingspan KoolDuct® System*. All flanges, gaskets, mastic, rivets, bolts etc. have been assumed insignificant.

Specification	Installed R-value	Thickness		Assumed Mineral Fibre density	Embodied Energy (MJ/ linear metre)	
		<i>Kingspan KoolDuct®</i>	Mineral Fibre		<i>Kingspan KoolDuct®</i>	Galvanised Sheet Steel with Mineral Fibre
TIMSA Warm Air	–	22 mm	29 mm	45 kg/m ³	993	1389
TIMSA Chilled Air & Dual Purpose	–	30 mm	50 mm	45 kg/m ³	1203	1485
BS 5422: 2001 Warm Air with 10°C ΔT	–	22 mm	34 mm	45 kg/m ³	993	1411
BS 5422: 2001 Warm Air with 15°C ΔT	–	22 mm	37 mm	45 kg/m ³	993	1425
BS 5422: 2001 Warm Air with 25°C ΔT	–	30 mm	44 mm	45 kg/m ³	1203	1457
BS 5422: 2001 Chilled Air at 15°C	–	22 mm	25 mm	45 kg/m ³	993	1371
BS 5422: 2001 Chilled Air at 12°C	–	22 mm	37 mm	45 kg/m ³	993	1425
BS 5422: 2001 Chilled Air at 10°C	–	30 mm	45 mm	45 kg/m ³	1203	1462
BCA 2008 Spec. J5.2–3 Table 3b	0.9	22 mm	38 mm	22 kg/m ³	993	1351
	1.5	30 mm	50 mm	22 kg/m ³	1203	1381
	1.8	33 mm	75 mm	22 kg/m ³	1282	1445
ANSI / ASHRAE / IESNA 90.1: 2007	3.5	7/8"	1 1/2"	0.75 pcf	993	1317
	6.0	7/8"	2 3/16"	0.75 pcf	993	1345
	8.0	1 3/16"	3"	0.75 pcf	1203	1377

It can be seen from the above that in all circumstances shown, the embodied energy of the *Kingspan KoolDuct® System* can be less than that for galvanised sheet steel insulated with mineral fibre (up to 30% less).

Project Specification

This section comprises a model specification for the *Kingspan KoolDuct® System* of pre-insulated ductwork. Whilst reasonably comprehensive, this specification may not address all related subjects to the level of detail required. Nevertheless, it can be modified as required for use as the basis for an actual project specification in accordance with applicable project drawings and specifications.

The format of this specification is such that the universal provisions as laid out at the outset, make reference to the subsequent Appendices which relate to specific regional requirements, these regions being:

UK & Ireland (Appendix A)



Australia (Appendix B)



Middle East (Appendix C)



North America (Appendix D)



1 General

- 1.1 When pressure / leakage testing is known to be necessary, the ductwork system shall be designed to the testing pressure.
- 1.2 The contractor shall include for the manufacture, fabrication, supply, delivery and installation of materials necessary for the ductwork systems described in this specification.
- 1.3 All materials and finishes shall be free from defects and maintained in good condition throughout the duration of the works.
- 1.4 The materials used in the fabrication of ductwork from the *Kingspan KoolDuct® System* shall be inherently proof against rotting, mould, fungal growth and attack by vermin, be non-hygroscopic and in all respects be suitable for continuous use throughout the range of operating temperatures and within the environment indicated.
- 1.5 Any works of unacceptable standard shall be removed and replaced at no cost to the contract.
- 1.6 The fabrication and installation of ductwork fabricated from the *Kingspan KoolDuct® System* shall be carried out by a fabricator and installer that has successfully completed a specialist training course provided by Kingspan Insulation Ltd. The contractor shall fully acquaint itself with all the site conditions and programme of works and shall execute its works within such confines and programme. A list of registered fabricators and installers can be obtained from Kingspan Insulation Ltd.
- 1.7 Insulation material containing CFC's or HCFC's shall not be accepted.

2 Scope of Works

Unless otherwise indicated, the *Kingspan KoolDuct® System* is suitable for use in the following applications:

- a. warm air ventilation distribution ductwork (insulated to suit temperatures);
- b. air conditioning distribution ductwork (insulated to suit temperatures and vapour sealed);
- c. fresh air intake ductwork to plant (insulated to suit temperatures and vapour sealed);
- d. ductwork returning air to plant (insulated to suit temperatures);
- e. ductwork exposed in external locations (with an additional weatherproof finish); and
- f. ductwork for room temperature non-chemical exhaust.

3 Materials

- 3.1 The panels used in the fabrication of ductwork from the *Kingspan KoolDuct® System* shall be *Kingspan KoolDuct®* rigid phenolic insulation panels of nominal dimensions 2950 mm x 1200 mm / 9.68 ft x 3.94 ft or 3930 mm x 1200 mm / 12.89 ft x 3.94 ft and minimum compressive strength 200 kPa / 29 psi, as manufactured by Kingspan Insulation Ltd and detailed in App. A1 / B1 / C1 / D1 (delete as applicable) of this specification.
- 3.2 *Kingspan KoolDuct®* rigid phenolic insulation panels shall comprise a 55–60 kg/m³ / 3.4–3.75 pcf nominal density CFC/HCFC-free rigid phenolic insulation core with zero Ozone Depletion Potential (ODP), autohesively bonded on both sides to a 25 micron / 1 mil low vapour permeability aluminium foil facing reinforced with a 5 mm / 0.2" glass scrim.
- 3.3 *Kingspan KoolDuct®* rigid phenolic insulation panels are available in thicknesses of 22 mm / 7/8", 30 mm 13/16" and 33 mm / 15/16". For determination of the thickness required to achieve a specified thermal performance refer to App. A2 / B2 / C2 / D2 (delete as applicable) of this specification.
- 3.4 All other components required for the fabrication of ductwork from the *Kingspan KoolDuct® System* including the silicone sealant, contact adhesive, aluminium tape, self-adhesive gasket, ductwork reinforcements, closures, connectors and flanges shall be as approved / supplied by Kingspan Insulation Ltd.

4 Fire & Smoke Performance

- 4.1 The rigid phenolic insulation panels used in the fabrication of ductwork and / or ductwork sections fabricated from the *Kingspan KoolDuct® System* shall achieve the fire and smoke performance requirements as detailed in App. A3 / B3 / C3/ D3 (delete as applicable) of this specification.

Fabrication of Ductwork

- 4.2 All ductwork fabricated from the *Kingspan KoolDuct® System* shall be fabricated in accordance with methods as approved Kingspan Insulation Ltd.
- 4.3 Ductwork sections fabricated from the *Kingspan KoolDuct® System* shall not exceed permitted air leakage limits as detailed in App. A4 / B4 / C4 / D4 (delete as applicable) of this specification.
- 4.4 All internal seams must be fully sealed with an unbroken layer of silicone sealant.

- 4.5 Each ductwork section must be duly connected with a jointing system approved Kingspan Insulation Ltd., and sufficient silicone sealant should be applied in order to seal the rigid phenolic insulation panel and ensure minimum air leakage.
- 4.6 Ductwork reinforcement, if necessary, shall be applied to protect against side deformation from both positive and negative pressure.
- 4.7 All external seams where two separate panels join must be taped to achieve a permanent bond and a smooth wrinkle free appearance.
- 4.8 The design of ductwork fittings shall be in conformance with the appropriate ductwork construction standard as detailed in App. A5 / B5 / C5 / D5 (delete as applicable) of this specification.
- 4.9 Access doors shall be provided where shown on the drawings. These may be fabricated from the *Kingspan KoolDuct® System* or, a commercially available pre-insulated access door may be incorporated. This access door must be insulated to the same standard as the *Kingspan KoolDuct®* rigid phenolic insulation panel and the integrity of the vapour barrier must be maintained.

5 Storage & Handling

- 5.1 Care shall be exercised in the handling and transportation of ductwork sections and the *Kingspan KoolDuct®* rigid phenolic insulation panels from which they are fabricated, in order to prevent physical damage.
- 5.2 All ductwork sections, and the materials from which they are fabricated, shall be stored under cover, clear of the ground and protected from the weather and sunlight by an opaque and light coloured waterproof material. In cases where the ductwork sections are to be stored for prolonged periods, the open ends of the ductwork sections shall be sealed with a polythene sheet or other suitable material to prevent the ingress of foreign matter.

Project Specification

6 Installation of Ductwork

- 6.1 Ductwork sections fabricated from the *Kingspan KoolDuct® System* shall be installed in accordance with methods approved by Kingspan Insulation Ltd.
- 6.2 The ductwork system shall be visually inspected before commencement of operation and ductwork sections fabricated from the *Kingspan KoolDuct® System* shall be verified as having been installed correctly.
- 6.3 Flexible connections shall be made between the ductwork and any item which is subject to vibration or movement.

Support

- 6.4 It shall be the responsibility of the installer to ensure that the ductwork system is properly and adequately supported. A number of support systems are approved for use by Kingspan Insulation Ltd. It shall be the responsibility of the installer to ensure that the chosen method of support is compatible with ductwork fabricated from the *Kingspan KoolDuct® System*.
- 6.5 With the exception of Tiger Supports, all metal support members in contact with the ductwork shall be separated by a soft gasket material.
- 6.6 Supports on straight runs of ductwork fabricated from the *Kingspan KoolDuct® System* shall be positioned at centres not exceeding 3 m / 10 ft for ductwork sections fabricated in 3 m / 10 ft lengths, and 4 m / 13 ft for ductwork sections fabricated in 4 m / 13 ft lengths.
- 6.7 Additionally, ductwork shall be supported at changes of direction, at branch duct connections, tee fittings and etc.
- 6.8 All ductwork accessories such as dampers shall be independently supported.

Internal Ductwork

- 6.9 All internal and exposed to view ductwork fabricated from *Kingspan KoolDuct® System* may be provided with a protective finish in addition to the factory applied reinforced aluminium facing. For details, refer to App. A6 / B6 / C6 / D6 (delete as applicable) of this specification.

External Ductwork

- 6.10 All externally mounted ductwork fabricated from the *Kingspan KoolDuct® System* must be installed with a slight fall so as to shed water from its upper surface and must be provided with a protective weatherproof finish that shields against the effects of wind and sunlight. For details, refer to App. A6 / B6 / C6 / D6 (delete as applicable) of this specification.

High Humidity Conditions

- 6.11 High humidity conditions may increase the risk of condensation forming on ductwork section jointing flanges. To combat this:
 - all flanges can be insulated to the same thickness as the ductwork insulation and fully vapour sealed; or
 - a tropical plastic flange can be used to replace the internal half of the aluminium grip flange, if specified.

In some high humidity conditions, a bloom may form on the surface of the ductwork. If this is likely to be visible, the ductwork can be painted with a suitable paint finish which does not compromise the factory applied reinforced aluminium facing or fire classification.

7 Testing for Air Leakage

Ductwork air leakage testing shall be conducted in conformance with the procedures as set out in the appropriate standard as detailed in App. A7 / B7 / C7 / D7 (delete as applicable) of this specification.

8 Commissioning & Operating Pressures

- 8.1 The commissioning process shall include for the testing and verification of functional performance, preparation of documentation, training of personnel for continued proper operation and maintenance of the ductwork system, and compilation of the final commissioning report.
- 8.2 The commissioning pressure shall not exceed the designed pressure limit when a ductwork system fabricated from the *Kingspan KoolDuct® System* is being commissioned.

9 Standards / References

App. A8 / B8 / C8 / D8 (delete as applicable)

Project Specification - Appendix A - UK & Ireland



Appendix A1 - Kingspan KoolDuct® Rigid Phenolic Insulation Panels

Description

Kingspan KoolDuct® rigid phenolic insulation panels have a CFC/HCFC-free rigid phenolic insulation core with a density range of 55–60 kg/m³. Manufactured by a continuous process, the quality of the insulation is constantly monitored and controlled. A closed cell structure makes the product non-wicking and highly resistant to moisture penetration and gives it excellent thermal properties. *Kingspan KoolDuct®* rigid phenolic insulation panels are faced on both sides with a protective low vapour permeability 25 micron aluminium foil reinforced with a 5 mm glass scrim which is extremely durable. *Kingspan KoolDuct®* rigid phenolic insulation panels are also available with a 23 micron black-coated aluminium foil reinforced with a 5 mm glass scrim facing on one side and the above mentioned aluminium foil on the other. *Kingspan KoolDuct®* rigid phenolic insulation panels are able to withstand temperatures from –20°C to +80°C. They also have an exceptional resistance to burning and spread of flame. The composition of *Kingspan KoolDuct®* rigid phenolic insulation panels is such that when subjected to fire the outer surface forms a carbonaceous layer which retards further flame spread and penetration.

Kingspan KoolDuct® rigid phenolic insulation panels satisfy the requirements of BS 5422: 2001, BS 5422: 2008, the TIMSA Guide and other major national specifications. *Kingspan KoolDuct®* rigid phenolic insulation panels are manufactured under a quality control system approved to BS EN ISO 9001: 2000 (Quality management systems. Requirements) and an environmental management system approved to BS EN ISO 14001: 2004 (Environmental management systems. Requirements with guidance for use).

Application

Kingspan KoolDuct® rigid phenolic insulation panels are a core component of the *Kingspan KoolDuct®* System of pre-insulated ductwork, which is an alternative to traditional sheet steel ductwork in Building Services / HVAC applications. The durable and puncture resistant aluminium foil facings on *Kingspan KoolDuct®* rigid phenolic insulation panels are used to prevent the ingress of moisture, dust and dirt into the insulation.

Availability

- Insulation panel dimensions: 2950 mm x 1200 mm
- Insulation panel thickness: 22 mm & 30 mm

General Physical Properties (Rigid Phenolic Insulation Core)

Property	Test Method	Typical Value
Colour		Pink
Minimum Closed Cell Content	(BS EN ISO 4590: 2003)	≥ 90%
Nominal Density Range		55–60 kg/m ³
Compressive Strength at 10% Compression	(BS EN 826: 1996)	200 kPa
Thermal Conductivity (22°C & 50% RH)	(ASTM C 518)	0.021 W/m·K
Water Vapour Resistance Z (23°C & 50% RH)	(BS EN 12086: 1997) Method A	617 MN·s/g
Operating Temperature Limits		–20°C to +80°C

Fire & Smoke Test Classifications (Rigid Phenolic Insulation Core)

Test	Test Method	Result
Fire Propagation	BS 476–6: 1989	Index of performance not exceeding 12 and sub index (i ₁) not exceeding 6*
Surface Spread of Flame	BS 476–7: 1997	Class 1*
Specific Optical Density of Smoke (Average)	BS 6401: 1983	22.7 with pilot flame 15 without pilot flame
Toxicity Index (Average)	Defence Standard 02–713: 2006	4.93

*The rigid phenolic insulation core of *Kingspan KoolDuct®* panels will achieve these results which enables it to be classified as Class 0 to the Building Regulations in England & Wales, Northern Ireland and the Republic of Ireland, and Low Risk to the Building Standards in Scotland.

General Physical Properties (Aluminium Foil Vapour Barrier Facing)

Property		Typical Value
Composition	Coated Aluminium Glass Scrim Glass Mat	25 microns 5 mm x 5 mm 49 g/m ²
Water Vapour Transmission		1.15 ng·N·s

Fire & Smoke Test Classifications (Aluminium Foil Vapour Barrier Facing)

Test	Test Method	Result
Fire Propagation	BS 476–6: 1989	Index of performance not exceeding 12 and sub index (i ₁) not exceeding 6*
Surface Spread of Flame	BS 476–7: 1997	Class 1*

*The aluminium foil vapour barrier facing of *Kingspan KoolDuct®* panels will achieve these results which enables it to be classified as Class 0 to the Building Regulations in England & Wales, Northern Ireland and the Republic of Ireland, and Low Risk to the Building Standards in Scotland.



Appendix A2 - Insulation Thickness Specifications

England & Wales and Northern Ireland – The TIMSA Guide

The 2006 editions of Approved Documents L2A & L2B to the Building Regulations in England & Wales and the 2006 edition of Technical Booklet F2 to the Building Regulations (Northern Ireland), refer directly and indirectly to the TIMSA “Domestic & Non-Domestic Heating, Cooling and Ventilation Guide” (the TIMSA Guide) as the reference document for the required thickness of duct insulation to control heat loss / gain.

The TIMSA Guide shows two tables for ductwork operating in different conditions:

- Table 6.2.4 Insulation for Warm Ducts; and
- Table 6.2.5 Insulation for Chilled & Dual Purpose Ducts.

The required thicknesses of insulation set out in the TIMSA Guide are shown in the tables below. (Please note that ductwork operating at temperatures outside those given in the tables will require specific calculations).

Air Temperature (°C)		Thickness (mm)		
Inside Duct	Ambient	Kingspan KoolDuct®	Mineral Fibre	Nitrile Rubber
35	15	18*	29	33
Estimated Mean Temperature of Insulation:				+20°C
Assumed Thermal Conductivity (k-value) of Insulation:				
Kingspan KoolDuct® (Low Emissivity Facing)			0.021 W/m·K	
Mineral Fibre (Low Emissivity Facing)**			0.035 W/m·K	
Nitrile Rubber (Class 0)			0.040 W/m·K	

Thickness (mm) of Insulation for Warm Ducting Service Areas to Control Heat Loss (Based on TIMSA Guide Section 6.2.4)

Air Temperature (°C)		Thickness (mm)	
Inside Duct	Ambient	Kingspan KoolDuct®	Mineral Fibre
13	25	30*	50
Ambient Air Temperature – Indoor:		+25°C	
Relative Humidity – Indoor:		80%	
Dewpoint Temperature:		+21.3°C	
Assumed Thermal Conductivity (k-value) of Insulation:			
Kingspan KoolDuct®		0.021 W/m·K	
Mineral Fibre**		0.035 W/m·K	

Thickness (mm) of Insulation for Chilled & Dual Purpose Ducting Service Areas to Control Heat Gain (Based on TIMSA Guide Section 6.2.5)

* Please note that the Kingspan KoolDuct® System is available in a 22 mm and 30 mm duct wall thickness only.

** At the average temperature of the insulation material, some mineral fibre duct insulation products may have a thermal conductivity lower than 0.035 W/m·K. For accurate thicknesses of those products please refer to a mineral fibre manufacturer. This table takes 0.035 W/m·K as a “safe” value.

It can be seen from the tables below that in all circumstances shown that:

- the 22 mm and 30 mm thick rigid phenolic insulation panels used in the Kingspan KoolDuct® System match or exceed the specification laid down in the TIMSA Guide; and
- the thickness of the 22 mm and 30 mm thick rigid phenolic insulation panels used in the Kingspan KoolDuct® System can be significantly less than the required thickness of mineral fibre (up to 40% thinner) or nitrile rubber (up to 33% thinner).

NB The Non-Domestic Heating, Cooling and Ventilation Compliance Guide refers to the TIMSA Guide for help with condensation control. The TIMSA Guide does not show a table of insulation thicknesses for the control of condensation on below ambient ductwork. Therefore, please refer to the table of thicknesses for the control of condensation on below ambient ductwork contained in BS 5422: 2001.

Republic of Ireland and Scotland – BS 5422: 2001

The 2008 edition of the Non-domestic Technical Handbook Section 6 to the Building Standards in Scotland, and the 2006 edition of Technical Guidance Document L to the Building Regulations in the Republic of Ireland, refer directly and indirectly to British Standard, BS 5422: 2001 (Method for specifying thermal insulating materials for pipes, tanks, vessels, ductwork and equipment operating within the temperature range –40°C to +700°C) as the reference document for the required thickness of duct insulation to control heat loss / gain.

NB An updated BS 5422: 2008 will be published late in 2008 and will supersede BS 5422: 2001. It is expected that the new BS 5422: 2008 will be used as the relevant standard in Scotland and the Republic of Ireland when it is published.

The insulation thickness tables for ductwork carrying warm air and for chilled and dual purpose ductwork in BS 5422: 2008 are identical to those shown in the TIMSA Guide. The insulation thickness table for condensation control for ductwork carrying chilled air in BS 5422: 2008 is identical to that shown in BS 5422: 2001.

BS 5422: 2001 shows two tables for ductwork operating in different conditions:

- Table 11 Insulation for Warm Ducts; and
- Table 10 Insulation for Condensation Control Ductwork Carrying Chilled Air in Ambient Conditions.



The required thicknesses of insulation set out in BS 5422: 2001 are shown in the tables below. (Please note that ductwork operating at temperatures outside those given in the tables will require specific calculations).

Temperature difference between air inside ductwork and ambient air (°C)	Thickness (mm)		
	Kingspan KoolDuct®	Mineral Fibre	Nitrile Rubber
10	20*	34	38
15	22*	37	42
25	27*	44	50
Estimated Mean Temperature of Insulation:		+20°C	
Assumed Thermal Conductivity (k-value) of Insulation:			
Kingspan KoolDuct®		0.021 W/m·K	
Mineral Fibre**		0.035 W/m·K	
Nitrile Rubber (Class 0)		0.040 W/m·K	

Environmental Thickness (mm) of Insulation for Ductwork Carrying Warm Air to Control Heat Loss (Based on BS 5422: 2001 Table 11)

Minimum air temperature inside ductwork (°C)	Thickness (mm)	
	Kingspan KoolDuct®	Mineral Fibre
15	16*	25
12	22*	37
10	28*	45
Ambient Air Temperature – Indoor:		+25°C
Relative Humidity – Indoor:		80%
Dewpoint Temperature:		+21.3°C
Assumed Thermal Conductivity (k-value) of Insulation:		
Kingspan KoolDuct®		0.021 W/m·K
Mineral Fibre**		0.035 W/m·K

Thickness (mm) of Insulation for Condensation Control Ductwork Carrying Chilled Air in Ambient Conditions (Based on BS 5422: 2001 Table 10)

* Please note that the Kingspan KoolDuct® System is available in a 22mm and 30 mm duct wall thickness only.

** At the average temperature of the insulation material, some mineral fibre duct insulation products may have a thermal conductivity lower than 0.035 W/m.K. For accurate thicknesses of those products please refer to a mineral fibre manufacturer. This table takes 0.035 W/m.K as a "safe" value.

It can be seen from the tables that in all circumstances shown that:

- the 22 mm and 30 mm thick rigid phenolic insulation panels used in the Kingspan KoolDuct® System match or exceed the specification laid down in BS 5422: 2001; and
- the thickness of the 22 mm and 30 mm thick rigid phenolic insulation panels used in the Kingspan KoolDuct® System can be significantly less than the required thickness of mineral fibre (up to 40% thinner) or nitrile rubber (up to 47% thinner).

Appendix A3 - Fire & Smoke Performance

The appropriate fire and smoke performance requirements for the UK & Ireland are detailed below.

Internal Ductwork

- BS 476-6: 1989 – of low contribution to fire growth with fire propagation index of performance (I) not exceeding 12 and sub index (i₁) not exceeding 6;
- BS 476-7: 1997 – of very low surface spread of flame (Class 1); and
- Class 0 / Low Risk to the Building Regulations / Standards.

External Ductwork

- BS 476-7: 1997 – of very low surface spread of flame (Class 1).

Appendix A4 - Air Leakage Limits

HVCA DW/144 details the maximum allowable air leakage as shown in the table below:

Duct Pressure Class	Static Pressure Limit (Pa)		Maximum Air Velocity (m/s)	Air Leakage Limits (l/s/m ²)
	Positive	Negative		
Low-Pressure (Class A)	500	500	10	0.027 x p ^{0.65}
Medium-Pressure (Class B)	1000	750	20	0.009 x p ^{0.65}
High-Pressure (Class C)	2000	750	40	0.003 x p ^{0.65}

p = static pressure differential (Pa)

Based on the limits set out in table above, the maximum allowable air leakage for each pressure class over a range of pressures from 0 to 2,000 Pascals (Pa) is plotted in the graph below. The leakage figures are given in litres of air per second per square metre (l/s/m²) of internally measured ductwork against a static pressure differential ranging from 100 Pa to 2,000 Pa.

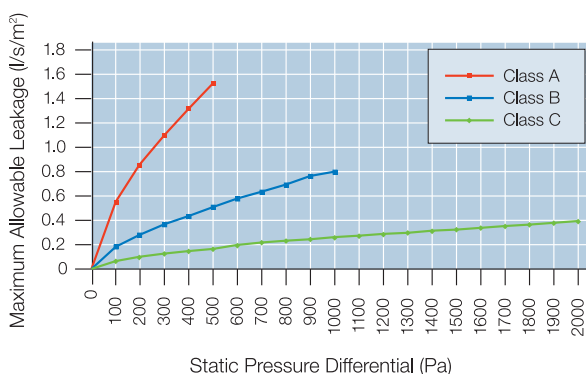



Appendix A5 - Ductwork Fittings

The appropriate ductwork construction standard for the UK & Ireland is HVCA DW/144 (Specification for Sheet Metal Ductwork).

Appendix A6 - Finishes

Internal Ductwork

The finish shall be either:

- a) aluminium / zinc alloy coated sheet steel (0.7 mm) (e.g. Dobel Aluzinc or equivalent) which can be introduced during fabrication of the ductwork or installed in situ; or
- b) a suitable paint finish (must not compromise factory applied reinforced aluminium facing or fire classification) applied in situ.

External Ductwork

The finish shall be either:

- a) an aluminium cladding / jacketing system (e.g. Venture Clad or equivalent) which can be introduced during fabrication of the ductwork or installed in situ;
- b) aluminium / zinc alloy coated sheet steel (0.8 mm) (e.g. Dobel Aluzinc or equivalent) which can be introduced during fabrication of the ducting or installed in situ;
- c) a fibre reinforced plastic (e.g. Fibaroll GR Grade or equivalent) which is introduced during the fabrication of the ductwork; or
- d) a polymeric weather covering (for sheltered locations) installed in situ.

Manufacturers of Finishes

For Dobel Aluzinc aluminium zinc alloy coated sheet steel refer to:

SSAB Dobel Coated Steel Ltd
Narrowboat Way
Hurst Business Park
Brierley Hill
West Midlands
DY5 1UF
Tel: +44 (0) 1384 74 660
Fax: +44 (0) 1384 77 575
www.dobel.co.uk

For Venture Clad aluminium jacketing system refer to:

Venture Tape Europe Corp.
Units 5-6
Faraday Close
Drayton Fields
Daventry
Northamptonshire
NN11 8RD
Tel: +44 (0) 1327 876 555
Fax: +44 (0) 1327 876 444
www.venturetape.com

For Fibaroll FR Grade fibre reinforced plastic coating for insulation refer to:

FTi Ltd
Willmotts Business Park
Waterlip
Somerset
BA4 4RN
Tel: +44 (0) 1749 881 920
Fax: +44 (0) 1749 880 843
www.fibaroll.co.uk

Appendix A7 - Testing for Air Leakage

Approved Documents L2A & L2B to the Building Regulations in England & Wales, and Technical Booklet F2 to the Building Regulations (Northern Ireland), state that ductwork leakage testing should be carried out in accordance with the procedures set out in HVCA DW/143 on systems served by fans with a design flow rate greater than 1 m³/s, and for those sections of ductwork where the pressure class is such that HVCA DW/143 recommends testing and the carbon dioxide emissions rate of the building design assumes a leakage rate for a given section of ductwork that is lower than the standard defined in HVCA DW/144 for its particular pressure class. Technical Handbook Section 6 to the Building Standards in Scotland state that one way of carrying out ductwork leakage testing is to follow the procedures set out in HVCA DW/143.

HVCA DW/143 (A Practical Guide to Ductwork Leakage Testing) recommends the range and frequency of testing that it deems to be satisfactory.

It recommends the following:

- high pressure ducts (Class C) – all tested;
- medium pressure ducts (Class B) – 10% of the ductwork selected at random and tested; and
- low pressure ducts (Class A) – untested.

It is also recommended:

- for medium pressure ducts, in the event of test failure of the randomly selected section, the designer shall have the right to select two further sections at random for testing. Where successive failures are identified there shall be a right to require the contractor to apply remedial attention to the complete ductwork system; and
- in general for all ducts tested, that the air leakage rate for any section shall not be in excess of the permitted rate (as stated in HVCA DW/144) for that section. If a first test produces leakage in excess of the permitted maximum, the section shall be resealed and retested until a leakage not greater than the permitted maximum for that section is achieved.



Appendix A8- Standards / References

British Standards

BS 476-6: 1989

Fire tests on building materials and structures. Method of test for fire propagation for products

BS 476-7: 1997

Fire tests on building materials and structures. Method of test to determine the classification of the surface spread of flame of products

BS 6401: 1983

Method for measurement, in the laboratory, of the specific optical density of smoke generated by materials.

BS 5422: 2001

Method for specifying thermal insulating materials for pipes, tanks, vessels, ductwork and equipment operating within the temperature range -40°C to $+700^{\circ}\text{C}$

BS 5422: 2008

Method for specifying thermal insulating materials for pipes, tanks, vessels, ductwork and equipment operating within the temperature range -40°C to $+700^{\circ}\text{C}$

BS EN 826:1996

Thermal insulating products for building applications. Determination of compression behaviour

BS EN 12086:1997

Thermal insulating products for building applications. Determination of water vapour transmission properties

BS EN ISO 4590: 2003

Rigid cellular plastics. Determination of the volume percentage of open cells and of closed cells

BS EN ISO 9001: 2000

Quality management systems. Requirements

BS EN ISO 14001: 2004

Environmental management systems. Requirements with guidance for use)

American Standards

ASTM C 518: 2004

Standard Test Method for Steady-State Thermal Transmission Properties by Means of the Heat Flow Meter Apparatus

Other References

TIMSA Guide

TIMSA Domestic & Non-Domestic Heating, Cooling and Ventilation Guide

HVCA DW/144

Specification for Sheet Metal Ductwork

HVCA DW/143

A practical guide to Ductwork Leakage Testing

Defence Standard 02-713: 2006

Determination of the Toxicity Index of the Products of Combustion from Small Specimens of Material

Building Regulations / Standards

England & Wales

The Building Regulations 2000. Approved Document B2. 2006 Edition, Amended 2007. Appendix A, Paragraph 13.

The Building Regulations 2000. Approved Document L2A. 2006 Edition.

The Building Regulations 2000. Approved Document L2B. 2006 Edition.

Scotland

The Building Standards (Scotland) Regulations. Non-domestic Technical Handbook Section 2 (Fire). 2008 Edition. Annex 2C.

The Building Standards (Scotland) Regulations. Non-domestic Technical Handbook Section 6 (Energy). 2008 Edition.

Northern Ireland

The Building Regulations (Northern Ireland) 2000. Technical Booklet E. 2005 Edition. Paragraph 2.4

The Building Regulations (Northern Ireland) 2000. Technical Booklet F2. 2006 Edition.

Irish Republic

The Building Regulations 2006. Technical Guidance Document B. Appendix A. Paragraphs A11 and A12

The Building Regulations 2005. Technical Guidance Document L. May 2006 Edition.

Project Specification - Appendix B - Australia



Appendix B1 - Kingspan KoolDuct® Rigid Phenolic Insulation Panels

Description

Kingspan KoolDuct® rigid phenolic insulation panels have a CFC/HCFC-free rigid phenolic insulation core with a density range of 55–60 kg/m³. Manufactured by a continuous process, the quality of the insulation is constantly monitored and controlled. A closed cell structure makes the product non-wicking and highly resistant to moisture penetration and gives it excellent thermal properties. *Kingspan KoolDuct®* rigid phenolic insulation panels are faced on both sides with a protective low vapour permeability 25 micron aluminium foil reinforced with a 5 mm glass scrim which is extremely durable. *Kingspan KoolDuct®* rigid phenolic insulation panels are also available with a 23 micron black-coated aluminium foil reinforced with a 5 mm glass scrim facing on one side and the above mentioned aluminium foil on the other.

Kingspan KoolDuct® rigid phenolic insulation panels are able to withstand temperatures from –20°C to +80°C. They also have an exceptional resistance to burning and spread of flame. The composition of *Kingspan KoolDuct®* rigid phenolic insulation panels is such that when subjected to fire the outer surface forms a carbonaceous layer which retards further flame spread and penetration.

Kingspan KoolDuct® rigid phenolic insulation panels satisfy the requirements of BCA 2008 Specifications C1.10–9 and J5.2–3. *Kingspan KoolDuct®* rigid phenolic insulation panels are manufactured under a quality control system approved to BS EN ISO 9001: 2000 (Quality management systems. Requirements) and an environmental management system approved to BS EN ISO 14001: 2004 (Environmental management systems. Requirements with guidance for use).

Application

Kingspan KoolDuct® rigid phenolic insulation panels are a core component of the *Kingspan KoolDuct®* System of pre-insulated ductwork, which is an alternative to traditional sheet steel ductwork in Building Services / HVAC applications. The durable and puncture resistant aluminium foil facings on *Kingspan KoolDuct®* rigid phenolic insulation panels are used to prevent the ingress of moisture, dust and dirt into the insulation.

Availability

- Insulation panel dimensions: 3930 mm x 1200 mm
- Insulation panel thickness: 22 mm, 30 mm & 33 mm

General Physical Properties (Rigid Phenolic Insulation Core)

Property	Test Method	Typical Value
Colour		Pink
Minimum Closed Cell Content	(BS EN ISO 4590: 2003)	≥ 90%
Nominal Density Range		55–60 kg/m ³
Compressive Strength at 10% Compression	(BS EN 826: 1996)	200 kPa
Thermal Conductivity (22°C & 50% RH)	(ASTM C 518: 2004)	0.21 W/m·K
Material R-value		
22 mm		1.05 m ² ·K/W
30 mm		1.43 m ² ·K/W
33 mm		1.57 m ² ·K/W
Water Vapour Resistance Z (23°C & 50% RH)	(BS EN 12086: 1997) Method A	617 MN·s/g
Operating Temperature Limits		–20°C to +80°C

General Physical Properties (Aluminium Foil Vapour Barrier Facing)

Property		Typical Value
Composition	Coated Aluminium	25 microns
	Glass Scrim	5 mm x 5 mm
	Glass Mat	49 g/m ²
Water Vapour Transmission		1.15 ng·N·s

Fire & Smoke Test Classifications (Rigid Phenolic Insulation Core & Aluminium Foil Vapour Barrier Facing)

Test	Test Method	Result
Early Fire Hazard	AS 1530–3: 1999	Ignitability Index: 0* Flame Spread Index: 0* Heat Developed Index: 0* Smoke Developed Index: 0–1*
Surface Burning Characteristics	UL 723 / ASTM E 84-08a	< 25/50
Burning	UL 181	Pass*

**Kingspan KoolDuct®* rigid phenolic insulation panels as part of an assembled ductwork system, will achieve these results which enables them to comply with the Building Code of Australia (BCA) 2008 Specification C1.10–9.



Total Thermal Resistance (R_t) of Ductwork Fabricated From the Kingspan KoolDuct® System Including the Effect of Low Emissivity Facings

Panel Thickness (mm)	Application	Ambient Conditions	Calculated R_t ($m^2 \cdot K/W$)
22	Cooling Application ¹	Ambient Air Flowing at 0.5 m/s	1.18
		Still Ambient Air	1.52
	Heating Application ²	Ambient Air Flowing at 0.5 m/s	1.15
		Still Ambient Air	1.47
30	Cooling Application ¹	Ambient Air Flowing at 0.5 m/s	1.57
		Still Ambient Air	1.91
	Heating Application ²	Ambient Air Flowing at 0.5 m/s	1.53
		Still Ambient Air	1.85
33	Cooling Application ¹	Ambient Air Flowing at 0.5 m/s	1.72
		Still Ambient Air	2.06
	Heating Application ²	Ambient Air Flowing at 0.5 m/s	1.67
		Still Ambient Air	1.99

¹ Calculated using 13°C supply air and 26°C ambient environment.
² Calculated using 30°C supply air and 18°C ambient environment.
 R_t determinations based upon AS / NZS 4859: 2002.
 Assumed Thermal Conductivity (k-value) of insulation at 23°C mean temp: 0.021 W/m.K.

Appendix B2 - Insulation Thickness Specifications

Building Code of Australia (BCA) 2008

The Energy Efficiency Provisions of BCA 2008 specify the minimum required thermal performance standards for ductwork insulation, meeting the requirements of AS NZS 4859-1: 2002, installed on air conditioning ductwork in Class 5 to 9 buildings.

BCA 2008 Specification J5.2-3 shows two tables with the minimum required total R-value for ductwork operating in different climate zones and locations:

- Table 3a Combined Heating and Cooling Ductwork Systems greater than 65k Wr & 65 kW_{heating} Capacity; and
- Table 3b Heating / Cooling Only Ductwork & Fittings for Ductwork Systems less than 65k Wr & 65 kW_{heating} Capacity

The different climate zones are shown on the map to the right.



BCA 2008 Climate Zone Map for Australian Locations



Appendix B2 - Insulation Thickness Specifications (Continued)

The **Kingspan KoolDuct**[®] rigid phenolic insulation panel thickness required to achieve the specified thermal performance standards as set out in the BCA 2008 Specification J5.2-3 tables are shown below.

NB that, in some climates, the minimum energy efficiency requirements may not be sufficient for condensation control. In such cases, the risk of condensation should be assessed and calculated as appropriate.

Ductwork Element	Different Duct Insulation Thicknesses (mm) for the Minimum Required R-values for Ductwork in Each Climate Zone						
	Evaporative Cooling System	Heating / Refrigerated Cooling Only System			Combined Heating & Refrigerated Cooling System		
	All Zones	Zones 1,3,4,6 & 7	Zones 2 & 5	Zone 8	Zones 1,3,4,6 & 7	Zones 2 & 5	Zone 8
Ductwork	R-0.6 22 / 25	R-1.0 22 / 38	R-1.0 22 / 38	R-1.5 30 / 50	R-1.5* 30 / 50	R-1.0 22 / 38	R-1.5 30 / 50
Fittings	R-0.4 22 / 25	R-0.4 22 / 25	R-0.4 22 / 25	R-0.4 22 / 25	R-0.4 22 / 25	R-0.4 22 / 25	R-0.4 22 / 25

**The minimum total R-value required may be reduced by R-0.5 for combined heating refrigerated cooling systems in climate zones 1,3, 4, 6 & 7 if the ductwork is located:*
 (a) under a suspended floor with an enclosed perimeter; or
 (b) in a roof space that has insulation of not less than R-0.5 directly beneath the roofing.
 Blue: Kingspan **KoolDuct**[®]: Assumed R-value : 22 mm (R-1.05); 30 mm (R-1.43); 33 mm (R-1.57).
 Red: Mineral Fibre: Assumed R-value: 25 mm (R-0.7); 38 mm (R-1.0); 50 mm (R-1.4); 75 mm (R-2.0).

Table B1 – Minimum Insulation Required to Achieve the Total R-values for Ductwork & Fittings in Each Climate Zone for Systems Less than 65 kW_{heating} Capacity (Based on BCA 2008 Spec J5.2-3 Table 3a)

Location of Ductwork & Fittings	Different Duct Insulation Thicknesses (mm) for the Minimum Required R-values for Ductwork in Each Climate Zone				
	Evaporative Cooling System	Heating / Refrigerated Cooling Only System			
	All Zones	Zones 1,3 & 4	Zones 2 & 5	Zones 6 & 7	Zone 8
Within a conditioned space other than where the space is the only or last space served	Nil	R-1.0 22 / 38	R-1.0 22 / 38	R-1.3 30 / 50	R-1.5 30 / 50
All other locations	R-0.9 22 / 38	R-1.8* 33 / 75	R-1.5 30 / 50	R-1.8 33 / 75	R-2.0 N/A / 75

**The minimum total R-value required may be reduced by R-0.5 for heating / refrigerated cooling only system ductwork and fittings in all other locations in climate zones 1,3 & 4 if the ductwork is located:*
 (a) under a suspended floor with an enclosed perimeter; or
 (b) in a roof space that has insulation of not less than R-0.5 directly beneath the roofing.
 Blue: Kingspan **KoolDuct**[®]: Assumed R-value : 22 mm (R-1.05); 30 mm (R-1.43); 33 mm (R-1.57).
 Red: Mineral Fibre: Assumed R-value: 25 mm (R-0.7); 38 mm (R-1.0); 50 mm (R-1.4); 75 mm (R-2.0).

Table B2 – Minimum Insulation Required to Achieve the Total R-values for Ductwork in Each Climate Zone for Systems Greater than 65 kW_{heating} Capacity (Based on BCA 2008 Spec J5.2-3 Table 3b)

It can be seen from the tables above that:

- in all circumstances shown that the 22 mm, 30 mm and 33 mm thick rigid phenolic insulation panels used in the **Kingspan KoolDuct**[®] System match or exceed the specification laid down in BCA 2008; and
- the thickness of the 22 mm, 30 mm and 33 mm thick rigid phenolic insulation panels used in the **Kingspan KoolDuct**[®] System can be significantly less than the required thickness of mineral fibre (up to 56% thinner).



Appendix B3 - Fire & Smoke Performance

The appropriate fire and smoke performance requirements for Australia are:

- AS 1530-3: 1999 – early fire hazard rating of low smoke developed index not exceeding 3 and flame spread, ignitability and heat evolved indices not exceeding 0; and
- UL 181 – of low contribution to fire growth to pass the burning test.

Air handling ductwork systems which meet the performance requirements as detailed above are defined as meeting the requirements of AS 4254: 2002 in compliance with the Building Code of Australia (BCA) 2008 Specification C1.10-9.

Appendix B4 - Air Leakage Limits

BCA 2008 Specification J5.2-3 refers to AS 4254: 2002 (Ductwork for air-handling systems in buildings) for ductwork sealing, and requires all ductwork installations to be made sufficiently airtight to ensure quiet and economical operation of the system. Currently for Australia, the Energy Efficiency Provisions of BCA 2008 do not refer to a standard / guidance document that clearly defines mandatory air leakage limits.

It is however, recommended that the maximum allowable air leakage limits as detailed in HVCA DW/144 (Specification for Sheet Metal Ductwork) or the SMACNA HVAC Air Duct Leakage Test Manual are not exceeded.

HVCA DW/144

HVCA DW/144 details the maximum allowable air leakage as shown in the table below:

Duct Pressure Class	Static Pressure Limit (Pa)		Maximum Air Velocity (m/s)	Air Leakage Limits (l/s/m ²)
	Positive	Negative		
Low-Pressure (Class A)	500	500	10	$0.027 \times p^{0.65}$
Medium-Pressure (Class B)	1000	750	20	$0.009 \times p^{0.65}$
High-Pressure (Class C)	2000	750	40	$0.003 \times p^{0.65}$

p = static pressure differential (Pa)

Based on the limits set out in table above, the maximum allowable air leakage for each pressure class over a range of pressures from 0–2000 Pascals (Pa) is plotted in the graph

below. The leakage figures are given in litres of air per second per square metre (l/s/m²) of internally measured ductwork against a static pressure differential ranging from 100–2000 Pa.

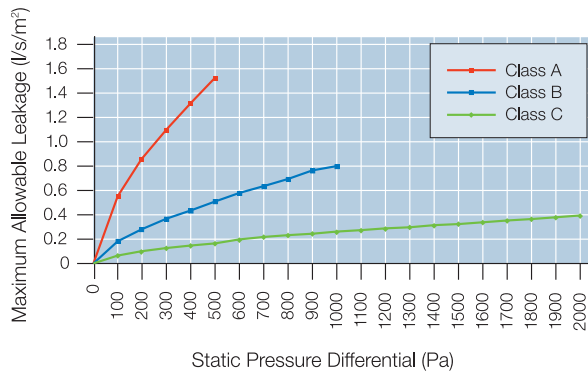

SMACNA HVAC Air Duct Leakage Test Manual

The SMACNA HVAC Air Duct Leakage Test Manual details the maximum allowable air leakage as shown in the table below:

Seal Class	Air Leakage Class (C _L)	Static Pressure (in.w.g.)	Air Leakage Limits (cfm/100 sq.ft)
A	6	≥ 4	$6 \times p^{0.65}$
B	12	3	$12 \times p^{0.65}$
C	24	≤ 2	$24 \times p^{0.65}$

p = static pressure (Pa)

Based on the limits set out in table above, the maximum allowable air leakage for each pressure and seal class is plotted in the graph below over a range of pressures from 0–4 in.w.g. (0–1000 Pa). The leakage figures are given in cubic feet of air per minute per one hundred square feet (cfm /100 sq. ft) of internally measured ductwork against a static pressure ranging from 0–4 in.w.g. (0–1000 Pa).

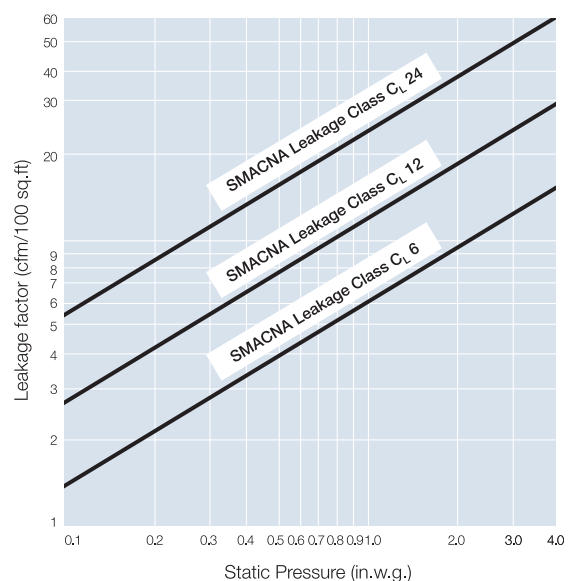



Appendix B5 - Design of Ductwork Fittings

The appropriate ductwork construction standard for Australia is AS 4254: 2002 (Ductwork for air-handling systems in buildings).

Appendix B6 - Finishes

Internal Ductwork

The finish shall be either:

- a) aluminium / zinc alloy coated sheet steel (0.7 mm) which can be introduced during fabrication of the ductwork or installed in situ; or
- b) a suitable paint finish (must not compromise factory applied reinforced aluminium facing or fire classification) applied in situ.

External Ductwork

The finish shall be either:

- a) an aluminium cladding / jacketing system which can be introduced during fabrication of the ductwork or installed in situ;
- b) aluminium / zinc alloy coated sheet steel (0.8 mm) which can be introduced during fabrication of the ducting or installed in situ;
- c) a fibre reinforced plastic which is introduced during the fabrication of the ductwork;
- d) a polymeric weather covering (for sheltered locations) installed in situ. or
- e) no. 10 open weave glass cloth embedded between two coats of trowel applied mastic.

Appendix B7 - Testing for Air Leakage

Currently for Australia, the Energy Efficiency Provisions of BCA 2008 do not refer to a standard / guidance document for ductwork leakage testing. However, if required, ductwork leakage testing shall be carried out in accordance with the procedures set out in HVCA DW/143 (A practical guide to Ductwork Leakage Testing) or the SMACNA HVAC Air Duct Leakage Test Manual.

HVCA DW/143

HVCA DW/143 recommends the range and frequency of testing that it deems to be satisfactory.

It recommends the following:

- high pressure ducts (Class C) – all tested;
- medium pressure ducts (Class B) – 10% of the ductwork selected at random and tested; and
- low pressure ducts (Class A) – untested.

It is also recommended:

- for medium pressure ducts, in the event of test failure of the randomly selected section, the designer shall have the right to select two further sections at random for testing. Where successive failures are identified there shall be a right to require the contractor to apply remedial attention to the complete ductwork system; and
- in general for all ducts tested, that the air leakage rate for any section shall not be in excess of the permitted rate (as stated in HVCA DW/144) for that section. If a first test produces leakage in excess of the permitted maximum, the section shall be resealed and retested until a leakage not greater than the permitted maximum for that section is achieved.

SMACNA HVAC Air Duct Leakage Test Manual

The SMACNA HVAC Air Duct Leakage Test Manual does not require testing for air leakage where adequate methods of assembly and sealing are used.

It recommends the following:

- high pressure ducts ≥ 4 in.w.g. (≥ 1000 Pa) – tested, if justified by the designer; and
- low – medium pressure ducts ≤ 3 in.w.g. (≤ 750 Pa) – untested.



Appendix B8- Standards / References

Australian / New Zealand Standards

AS / NZS 1530-3: 1999

Methods for fire tests on building materials, components and structures – Simultaneous determination of ignitability, flame propagation, heat release and smoke release

AS / NSZ 4859-1: 2002 / Amdt 1: 2006

Materials for the Thermal Insulation of Buildings – General Criteria and technical provisions.

AS 4254: 2002

Ductwork for air-handling systems in buildings

British Standards

BS EN 826:1996

Thermal insulating products for building applications.
Determination of compression behaviour

BS EN 12086:1997

Thermal insulating products for building applications.
Determination of water vapour transmission properties

BS EN ISO 4590: 2003

Rigid cellular plastics. Determination of the volume percentage of open cells and of closed cells

BS EN ISO 9001: 2000

Quality management systems. Requirements

BS EN ISO 14001: 2004

Environmental management systems. Requirements with guidance for use)

American Standards

ASTM C 518: 2004

Standard Test Method for Steady-State Thermal Transmission Properties by Means of the Heat Flow Meter Apparatus

Other References

HVCA DW/144

Specification for Sheet Metal Ductwork

HVCA DW/143

A practical guide to Ductwork Leakage Testing

SMACNA

HVAC Air Duct Test Leakage Manual

Building Codes

Building Code of Australia (BCA 2008)

Volume 2 Class 5 to 9 Buildings Specification C1.10-9

Building Code of Australia (BCA 2008)

Volume 2 Class 5 to 9 Buildings Specification J5.2-3

Project Specification - Appendix C - Middle East



Appendix C1 - Kingspan KoolDuct® Rigid Phenolic Insulation Panels

Description

Kingspan KoolDuct® rigid phenolic insulation panels have a CFC/HCFC-free rigid phenolic insulation core with a density range of 55–60 kg/m³ / 3.43–3.75 pcf. Manufactured by a continuous process, the quality of the insulation is constantly monitored and controlled. A closed cell structure makes the product non-wicking and highly resistant to moisture penetration and gives it excellent thermal properties. Kingspan KoolDuct® rigid phenolic insulation panels are faced on both sides with a protective low vapour permeability 25 micron / 1 mil aluminium foil reinforced with a 5 mm / 0.2" glass scrim which is extremely durable. Kingspan KoolDuct® rigid phenolic insulation panels are also available with a 23 micron / 0.9 mil black-coated aluminium foil reinforced with a 5 mm / 0.2" glass scrim facing on one side and the above mentioned aluminium foil on the other.

Kingspan KoolDuct® rigid phenolic insulation panels are able to withstand temperatures from -20°C to +80°C / 4°F to + 176°F. They also have an exceptional resistance to burning and spread of flame. The composition of Kingspan KoolDuct® rigid phenolic insulation panels is such that when subjected to fire the outer surface forms a carbonaceous layer which retards further flame spread and penetration.

Kingspan KoolDuct® rigid phenolic insulation panels satisfy the requirements of the UAE Ministry of Interior Dubai Civil Defense, BS 5422: 2001 (Method for specifying thermal insulating materials for pipes, tanks, vessels, ductwork and equipment operating within the temperature range -40°C to +700°C / -40°F to -1292°C) and ANSI / ASHRAE / IESNA 90.1: 2007 (Energy Standard for Buildings Except Low-Rise Residential Buildings) and other major specifications. Kingspan KoolDuct® rigid phenolic insulation panels are manufactured under a quality control system approved to BS EN ISO 9001: 2000 (Quality management systems. Requirements) and an environmental management system approved to BS EN ISO 14001: 2004 (Environmental management systems. Requirements with guidance for use).

Application

Kingspan KoolDuct® rigid phenolic insulation panels are a core component of the Kingspan KoolDuct® System of pre-insulated ductwork, which is an alternative to traditional sheet steel ductwork in Building Services / HVAC applications. The durable and puncture resistant aluminium foil facings on Kingspan KoolDuct® rigid phenolic insulation panels are used to prevent the ingress of moisture, dust and dirt into the insulation.

Availability

- Insulation panel dimensions: 3930 mm x 1200 mm / 12.89 ft x 3.94 ft
- Insulation panel thickness: 22 mm / 7/8" & 30 mm / 1 3/16"

General Physical Properties (Rigid Phenolic Insulation Core)

Property	Test Method	Typical Value
Colour		Pink
Minimum Closed Cell Content	(BS EN ISO 4590: 2003)	≥ 90%
Nominal Density Range		55–60 kg/m ³ / 3.43–3.75 pcf
Compressive Strength at 10% Compression	(BS EN 826: 1996)	200 kPa / 29 psi
Thermal Conductivity (23°C / 75°F & 50% RH)	(ASTM C 518)	0.021 W/m·K / 0.146 Btu-in/ft ² ·hr·°F
R-value:		
22 mm / 7/8"		1.05 m ² ·K/W / 6.0 ft ² ·hr·°F/Btu
30 mm / 1 3/16"		1.43 m ² ·K/W / 8.1 ft ² ·hr·°F/Btu
Water Vapour Transmission (23°C / 75°F & 50% RH)	(ASTM E 96)	617 MN·s/g / 0.34 grains/hr·ft ²
Operating Temperature Limits		-20°C to +80°C / -4°F to + 176°F

General Physical Properties (Aluminium Foil Vapour Barrier Facing)

Property		Typical Value
Composition	Coated Aluminium Glass Scrim Glass Mat	25 microns / 1 mil 5 mm x 5 mm / 0.2" x 0.2" 49 g/m ² / 30 lb/3000 ft ²
Water Vapour Transmission		1.15 ng·N·s / 0.02 perm (grains/ft ² ·hr·in·Hg)

Fire & Smoke Test Classifications (Rigid Phenolic Insulation Core & Aluminium Foil Vapour Barrier Facing)

Test	Test Method	Result
Surface Burning Characteristics	UL 723 / ASTM E 84-08a	< 25/50*
Burning	UL 181	Pass*
Fire Propagation	BS 476-6: 1989	index of performance not exceeding 12 and sub index (i ₁) not exceeding 6**
Surface Spread of Flame	BS 476-7: 1997	Class 1**
Specific Optical Density of Smoke (Average)	BS 6401: 1983	22.7 with pilot flame & 15 without pilot flame
Toxicity Index (Average)	Defence Standard 02-713: 2006	4.93

* These results from a series of tests enables the Kingspan KoolDuct® System to be UL Listed as a Class 1 Air Duct to Standard UL 181.

** The rigid phenolic insulation core of Kingspan KoolDuct® panels will achieve these results which enables it to be classified as Class 0 to the Building Regulations in England & Wales, Northern Ireland and the Republic of Ireland.



Appendix C2 - Insulation Performance Specifications

The installed insulation thickness shall be in accordance with the requirements of the relevant jurisdiction.

BS 5422: 2001 or ANSI / ASHRAE / IESNA 90.1: 2007 are often used as the minimum ductwork insulation thickness standard.

NB that, in some climates, the minimum energy efficiency requirements may not be sufficient for condensation control. In such cases, the risk of condensation should be assessed and calculated as appropriate.

BS 5422: 2001

BS 5422: 2001 shows two tables for ductwork operating in different conditions:

- Table 11 Insulation for Warm Ductwork; and
- Table 10 Insulation for Condensation Control Ductwork Carrying Chilled Air in Ambient Conditions.

The required thicknesses of insulation set out in BS 5422: 2001 are shown in the tables below. (Please note that ductwork operating at temperatures outside those given in the tables will require specific calculations).

NB An updated BS 5422: 2008 will be published late in 2008 and will supersede BS 5422: 2001. It is expected that the new BS 5422: 2008 will be used as the relevant standard when it is published.

Temperature difference between air inside ductwork and ambient air (°C)	Thickness (mm)		
	Kingspan KoolDuct®	Mineral Fibre	Nitrile Rubber
10	20*	34	38
15	22*	37	42
25	27*	44	50
Estimated Mean Temperature of Insulation:		+20°C	
Assumed Thermal Conductivity (k-value) of Insulation:			
Kingspan KoolDuct®		0.021 W/m-K	
Mineral Fibre**		0.035 W/m-K	
Nitrile Rubber (Class 0)		0.040 W/m-K	

Environmental Thickness (mm) of Insulation for Ductwork Carrying Warm Air to Control Heat Loss (Based on BS 5422: 2001 Table 11)

Minimum air temperature inside ductwork (°C)	Thickness (mm)	
	Kingspan KoolDuct®	Mineral Fibre
15	16*	25
12	22*	37
10	28*	45
Ambient Air Temperature – Indoor:		+25°C
Relative Humidity – Indoor:		80%
Dewpoint Temperature:		+21.3°C
Assumed Thermal Conductivity (k-value) of Insulation:		
Kingspan KoolDuct®		0.021 W/m-K
Mineral Fibre**		0.035 W/m-K

Thickness (mm) of Insulation for Condensation Control Ductwork Carrying Chilled Air in Ambient Conditions (Based on BS 5422: 2001 Table 10)

* Please note that the Kingspan KoolDuct® System is available in a 22 mm and 30 mm duct wall thickness only.

** At the average temperature of the insulation material, some mineral fibre duct insulation products may have a thermal conductivity lower than 0.035 W/m-K. For accurate thicknesses of those products please refer to a mineral fibre manufacturer. This table takes 0.035 W/m-K as a "safe" value.

It can be seen from the tables that in all circumstances shown that:

- the 22 mm and 30 mm thick rigid phenolic insulation panels used in the Kingspan KoolDuct® System match or exceed the specification laid down in BS 5422: 2001; and
- the thickness of the 22 mm and 30 mm thick rigid phenolic insulation panels used in the Kingspan KoolDuct® System can be significantly less than the required thickness of mineral fibre (up to 40% thinner) or nitrile rubber (up to 47% thinner).

Project Specification - Appendix C - Middle East



Appendix C2 - Insulation Performance Specifications (Continued)

ANSI / ASHRAE / IESNA 90.1: 2007

ANSI / ASHRAE / IESNA 90.1: 2007 shows two tables with minimum required R-values for ductwork insulation operating in different conditions:

- Table 6.8.2A Heating / Cooling Only Supply & Return Ductwork; and
- Table 6.8.2B Combined Heating & Cooling Supply & Return Ductwork.

The *Kingspan KoolDuct*® rigid phenolic insulation panel thickness and mineral fibre duct wrap thickness required to achieve the specified thermal performance standards as set out in the ANSI / ASHRAE / IESNA 90.1: 2007 tables are shown below.

Different Duct Insulation Thicknesses for the Minimum Required Insulation R-values for Ductwork Operating in Different Conditions						
Condition	Ductwork Location					
	Exterior	Ventilated Attic	Unvented Attic Above Insulated Ceiling ¹	Unvented Attic with Roof Insulation ²	Unconditioned Space ³	
Heating Only Ductwork						
Very Hot & Dry / Humid	Nil	Nil	Nil	Nil	Nil	
Hot & Dry / Humid	R-3.5 <i>7/8" / 1 1/2"</i>	Nil	Nil	Nil	Nil	
Warm & Dry / Humid	R-3.5 <i>7/8" / 1 1/2"</i>	Nil	Nil	Nil	Nil	
Cool & Dry / Humid	R-6.0 <i>7/8" / 2 3/16"</i>	R-3.5 <i>7/8" / 1 1/2"</i>	Nil	Nil	Nil	
Cooling Only Ductwork						
Very Hot & Humid	R-6.0 <i>7/8" / 2 3/16"</i>	R-6.0 <i>7/8" / 2 3/16"</i>	R-8.0 <i>1 3/16" / 3"</i>	R-3.5 <i>7/8" / 1 1/2"</i>	R-3.5 <i>7/8" / 1 1/2"</i>	
Very Hot & Dry / Humid	R-6.0 <i>7/8" / 2 3/16"</i>	R-6.0 <i>7/8" / 2 3/16"</i>	R-6.0 <i>7/8" / 2 3/16"</i>	R-3.5 <i>7/8" / 1 1/2"</i>	R-3.5 <i>7/8" / 1 1/2"</i>	
Hot & Dry / Humid	R-6.0 <i>7/8" / 2 3/16"</i>	R-6.0 <i>7/8" / 2 3/16"</i>	R-6.0 <i>7/8" / 2 3/16"</i>	R-3.5 <i>7/8" / 1 1/2"</i>	R-1.9 <i>7/8" / 1 1/2"</i>	
Warm & Dry / Humid	R-3.5 <i>7/8" / 1 1/2"</i>	R-3.5 <i>7/8" / 1 1/2"</i>	R-6.0 <i>7/8" / 2 3/16"</i>	R-1.9 <i>7/8" / 1 1/2"</i>	R-1.9 <i>7/8" / 1 1/2"</i>	
Cool & Dry / Humid	R-3.5 <i>7/8" / 1 1/2"</i>	R-1.9 <i>7/8" / 1 1/2"</i>	R-3.5 <i>7/8" / 1 1/2"</i>	R-1.9 <i>7/8" / 1 1/2"</i>	R-1.9 <i>7/8" / 1 1/2"</i>	
Return Ductwork						
All	R-3.5 <i>7/8" / 1 1/2"</i>	R-3.5 <i>7/8" / 1 1/2"</i>	R-3.5 <i>7/8" / 1 1/2"</i>	Nil	Nil	

1 Insulation R-values, measured in ft²·hr²·°F/Btu, are for the insulation as installed and do not include film resistance. The required minimum thicknesses do not consider water vapor transmission and possible surface condensation. Where exterior walls are used as plenum walls, wall insulation shall be as required by the most reflective condition of 6.4.4.2 or section 5 of ANSI / ASHRAE / IESNA 90.1: 2007. Insulation resistance measured on a horizontal plane in accordance with ASTM C 518 at a mean temperature of 75°F at the installed thickness.

2 Includes both ventilated and non ventilated crawlspaces.

3 Includes return air plenums with or without exposed roofs above.

Blue: Kingspan KoolDuct®: Assumed Installed R-value: 7/8" (R-6.0); 1 3/16" (R-8.1).

Red: Mineral Fibre: Assumed Installed R-value @ 25% Compression: 1 1/2" (R-4.2); 2 3/16" (R-6.0); 3" (R-8.4).

Table C1 – Minimum Required Insulation R-value¹ for Heating & Cooling Only Supply & Return Ductwork (Based on ANSI / ASHRAE / IESNA Standard 90.1: 2007 Table 6.8.2A)



Different Duct Insulation Thicknesses for the Minimum Required Insulation R-values for Ductwork Operating in Different Conditions					
Condition	Ductwork Location				
	Exterior	Ventilated Attic	Unvented Attic Above Insulated Ceiling ¹	Unvented Attic with Roof Insulation ²	Unconditioned Space ³
Supply Ductwork					
Very Hot & Humid	R-6.0 <i>7/8" / 2³/₁₆"</i>	R-6.0 <i>7/8" / 2³/₁₆"</i>	R-8.0 <i>1³/₁₆" / 3"</i>	R-3.5 <i>7/8" / 1¹/₂"</i>	R-3.5 <i>7/8" / 1¹/₂"</i>
Very Hot & Dry / Humid	R-6.0 <i>7/8" / 2³/₁₆"</i>	R-6.0 <i>7/8" / 2³/₁₆"</i>	R-6.0 <i>1³/₁₆" / 2³/₁₆"</i>	R-3.5 <i>7/8" / 1¹/₂"</i>	R-3.5 <i>7/8" / 1¹/₂"</i>
Hot & Dry / Humid	R-6.0 <i>7/8" / 2³/₁₆"</i>	R-6.0 <i>7/8" / 2³/₁₆"</i>	R-6.0 <i>1³/₁₆" / 2³/₁₆"</i>	R-3.5 <i>7/8" / 1¹/₂"</i>	R-3.5 <i>7/8" / 1¹/₂"</i>
Warm & Dry / Humid	R-6.0 <i>7/8" / 2³/₁₆"</i>	R-6.0 <i>7/8" / 2³/₁₆"</i>	R-6.0 <i>1³/₁₆" / 2³/₁₆"</i>	R-3.5 <i>7/8" / 1¹/₂"</i>	R-3.5 <i>7/8" / 1¹/₂"</i>
Cool & Dry / Humid	R-6.0 <i>7/8" / 2³/₁₆"</i>	R-6.0 <i>7/8" / 2³/₁₆"</i>	R-6.0 <i>1³/₁₆" / 2³/₁₆"</i>	R-1.9 <i>7/8" / 1¹/₂"</i>	R-3.5 <i>7/8" / 1¹/₂"</i>
Return Ductwork					
All	R-3.5 <i>7/8" / 1¹/₂"</i>	R-3.5 <i>7/8" / 1¹/₂"</i>	R-3.5 <i>7/8" / 1¹/₂"</i>	Nil	Nil

1 Insulation R-values, measured in ft²·hr·°F/Btu, are for the insulation as installed and do not include film resistance. The required minimum thicknesses do not consider water vapor transmission and possible surface condensation. Where exterior walls are used as plenum walls, wall insulation shall be as required by the most reflective condition of 6.4.4.2 or section 5 of ANSI / ASHRAE / IESNA 90.1: 2007. Insulation resistance measured on a horizontal plane in accordance with ASTM C 518 at a mean temperature of 75°F at the installed thickness.
2 Includes both ventilated and non ventilated crawlspaces.
3 Includes return air plenums with or without exposed roofs above.
Blue: Kingspan **KoolDuct**®: Assumed Installed R-value: 7/8" (R-6.0); 1³/₁₆" (R-8.1).
Red: Mineral Fibre: Assumed Installed R-value @ 25% Compression: 1¹/₂" (R-4.2); 2³/₁₆" (R-6.0); 3" (R-8.4).

Table C2 – Minimum Required Insulation R-value¹ for Combined Heating & Cooling Supply & Return Ductwork (Based on ANSI / ASHRAE / IESNA Standard 90.1: 2007 Table 6.8.2B)

It can be seen from the tables above that:

- in all circumstances shown that the 7/8" (R-6.0) and 1³/₁₆" (R-8.1) thick rigid phenolic insulation panels used in the **Kingspan KoolDuct**® System match or exceed the specification laid down in ANSI / ASHRAE / IESNA 90.1: 2007; and
- the thickness of the 7/8" and 1³/₁₆" thick rigid phenolic insulation panels used in the **Kingspan KoolDuct**® System can be significantly less than the required thickness of fiber glass (up to 60% thinner).

Appendix C3 - Fire & Smoke Performance

The appropriate fire and smoke performance requirements for the Middle East are:

- BS 476-6: 1989 – of low contribution to fire growth with fire propagation index of performance (I) not exceeding 12 and sub index (i₁) not exceeding 6;
- BS 476-7: 1997 – of very low surface spread of flame (Class 1); and
- Class 0 to the Building Regulations in England & Wales, Northern Ireland and the Republic of Ireland.
- ASTM E 84-08a – unfaced or composite (insulation, facing and adhesive) of low contribution to fire growth not exceeding 25 Flame Spread and 50 Smoke Developed indices;
- UL 723 – unfaced or composite (insulation, facing and adhesive) of low contribution to fire growth not exceeding 25 Flame Spread and 50 Smoke Developed indices; and
- UL 181 – UL classification as a Class 1 Air Duct.



Appendix C4 - Air Leakage Limits

Ductwork system air leakage shall be in accordance with the requirements of the relevant jurisdiction.

The maximum allowable air leakage limits as detailed in HVCA DW/144 (Specification for Sheet Metal Ductwork) or the SMACNA HVAC Air Duct Leakage Test Manual are often used.

HVCA DW/144 details the maximum allowable air leakage as shown in the table below:

Duct Pressure Class	Static Pressure Limit (Pa)		Maximum Air Velocity (m/s)	Air Leakage Limits (l/s/m ²)
	Positive	Negative		
Low-Pressure (Class A)	500	500	10	$0.027 \times p^{0.65}$
Medium-Pressure (Class B)	1000	750	20	$0.009 \times p^{0.65}$
High-Pressure (Class C)	2000	750	40	$0.003 \times p^{0.65}$

p = static pressure differential (Pa)

Based on the limits set out in the table above, the maximum allowable air leakage for each pressure class over a range of pressures from 0 to 2,000 Pascals (Pa) is plotted in the graph below. The leakage figures are given in litres of air per second per square metre (l/s/m²) of internally measured ductwork against a static pressure differential ranging from 100 Pa to 2,000 Pa.

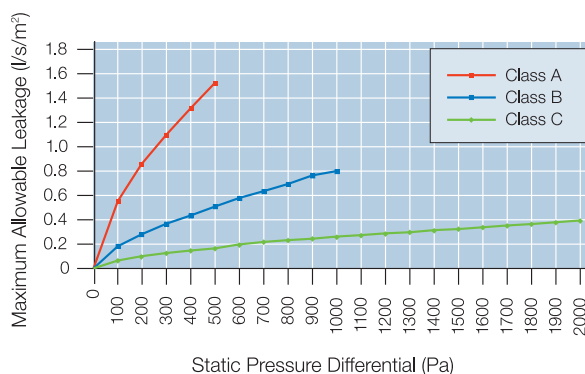

SMACNA HVAC Air Duct Leakage Test Manual

The SMACNA HVAC Air Duct Leakage Test Manual details the maximum allowable air leakage as shown in the table below:

Seal Class	Air Leakage Class (CL)	Static Pressure (in.w.g.)	Air Leakage Limits (cfm/100 sq.ft)
A	6	≥ 4	$6 \times p^{0.65}$
B	12	3	$12 \times p^{0.65}$
C	24	≤ 2	$24 \times p^{0.65}$

p = static pressure (in.w.g.)

Based on the limits set out in the table above, the maximum allowable air leakage for each pressure and seal class is plotted in the graph above right over a range of pressures from 0–4 in.w.g.

The leakage figures are given in cubic feet of air per minute per one hundred square feet (cfm/100 sq. ft) of internally measured ductwork against a static pressure ranging from 0–4 in.w.g.

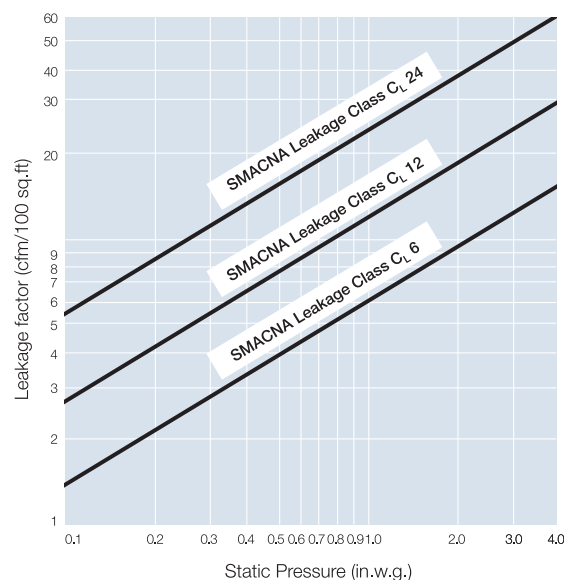

Appendix C5 - Ductwork Fittings

The appropriate ductwork construction standard is HVCA DW/144 or the SMACNA HVAC Duct System Design Manual.

Appendix C6 - Finishes

Internal Ductwork

The finish shall be either:

- aluminium / zinc alloy coated sheet steel (0.7 mm / 0.028") which can be introduced during fabrication of the ductwork or installed in place; or
- a suitable paint finish (must not compromise factory applied reinforced aluminium facing or fire classification) applied in place.

External Ductwork

The finish shall be either:

- an aluminium cladding / jacketing system which can be introduced during fabrication of the ductwork or installed in place;
- aluminium / zinc alloy coated sheet steel (0.8 mm / 0.032") which can be introduced during fabrication of the ducting or installed in place;
- a fibre reinforced plastic which is introduced during the fabrication of the ductwork;
- a polymeric weather covering (for sheltered locations) installed in place; or
- no. 10 open weave glass cloth embedded between two coats of trowel applied mastic.



Appendix C7 - Testing for Air Leakage

Ductwork air leakage testing shall be carried out in accordance with the requirements of the relevant jurisdiction.

Ductwork leakage testing shall be carried out in accordance with the procedures set out in HVCA DW/144 or the SMACNA HVAC Air Duct Leakage Test Manual

HVCA DW/143

HVCA DW/143 recommends the range and frequency of testing that it deems to be satisfactory.

It recommends the following:

- high pressure ducts (Class C) – all tested;
- medium pressure ducts (Class B) – 10% of the ductwork selected at random and tested; and
- low pressure ducts (Class A) – untested.

It is also recommended:

- for medium pressure ducts, in the event of test failure of the randomly selected section, the designer shall have the right to select two further sections at random for testing. Where successive failures are identified there shall be a right to require the contractor to apply remedial attention to the complete ductwork system; and
- in general for all ducts tested, that the air leakage rate for any section shall not be in excess of the permitted rate (as stated in HVCA DW/144) for that section. If a first test produces leakage in excess of the permitted maximum, the section shall be resealed and retested until a leakage not greater than the permitted maximum for that section is achieved.

SMACNA HVAC Air Duct Leakage Test Manual

The SMACNA HVAC Air Duct Leakage Test Manual does not require testing for air leakage where adequate methods of assembly and sealing are used.

It recommends the following:

- high pressure ducts ≥ 4 in.w.g. (≥ 1000 Pa) – tested, if justified by the designer; and
- low – medium pressure ducts ≤ 3 in.w.g. (≤ 750 Pa) – untested.

Appendix C8- Standards / References

British Standards

BS 476-6: 1989

Fire tests on building materials and structures. Method of test for fire propagation for products

BS 476-7: 1997

Fire tests on building materials and structures. Method of test to determine the classification of the surface spread of flame of products

BS 6401: 1983

Method for measurement, in the laboratory, of the specific optical density of smoke generated by materials.

BS 5422: 2001

Method for specifying thermal insulating materials for pipes, tanks, vessels, ductwork and equipment operating within the temperature range -40°C to $+700^{\circ}\text{C}$

BS EN 826:1996

Thermal insulating products for building applications. Determination of compression behaviour

BS EN 12086:1997

Thermal insulating products for building applications. Determination of water vapour transmission properties

BS EN ISO 4590: 2003

Rigid cellular plastics. Determination of the volume percentage of open cells and of closed cells

BS EN ISO 9001: 2000

Quality management systems. Requirements

BS EN ISO 14001: 2004

Environmental management systems. Requirements with guidance for use)

American Standards

ASTM C 518: 2004

Standard Test Method for Steady-State Thermal Transmission Properties by Means of the Heat Flow Meter Apparatus

ASTM E96 / E96M-05

Standard Test Methods for Water Vapour Transmission of Materials

ASTM E 84-08a

Standard Test Method for Surface Burning Characteristics of Building Materials

UL 723

Test for Surface Burning Characteristics of Building Materials

UL 181

Standard for Safety Factory Made Air Ducts and Connectors

Other References

HVCA DW/144

Specification for Sheet Metal Ductwork

HVCA DW/143

A practical guide to Ductwork Leakage Testing

SMACNA HVAC Duct System Design Manual

SMACNA HVAC Air Duct Leakage Test Manual

ANSI / ASHRAE / IESNA 90.1: 2007

Energy Standard for Buildings Except Low-Rise Residential Buildings Sections 5 & 6

Project Specification - Appendix D - North America



Appendix D1 - Kingspan KoolDuct® Rigid Phenolic Insulation Panels

Description

Kingspan KoolDuct® rigid phenolic insulation panels have a CFC/HCFC-free rigid phenolic insulation core with a density range of 3.43–3.75 pcf. Manufactured by a continuous process, the quality of the insulation is constantly monitored and controlled. A closed cell structure makes the product non-wicking and highly resistant to moisture penetration and gives it excellent thermal properties. *Kingspan KoolDuct®* rigid phenolic insulation panels are jacketed on both sides with a protective low vapor permeability 1 mil aluminum foil reinforced with a 0.2" glass scrim which is extremely durable. *Kingspan KoolDuct®* rigid phenolic insulation panels are also available with a 0.9 mil black-coated aluminum foil reinforced with a 0.2" glass scrim jacket on one side and the above mentioned aluminum foil on the other.

Kingspan KoolDuct® rigid phenolic insulation panels are able to withstand temperatures from -4°F to + 176°F. They also have an exceptional resistance to burning and spread of flame. The composition of *Kingspan KoolDuct®* rigid phenolic insulation panels is such that when subjected to fire the outer surface forms a carbonaceous layer which retards further flame spread and penetration.

Kingspan KoolDuct® rigid phenolic insulation panels satisfy the requirements of ANSI / ASHRAE / IESNA 90.1: 2007 (Energy Standard for Buildings Except Low-Rise Residential Buildings) and IECC (International Energy Conservation Code) 2003 & 2006 and other major national specifications. *Kingspan KoolDuct®* rigid phenolic insulation panels are manufactured under a quality control system approved to BS EN ISO 9001: 2000 (Quality management systems. Requirements) and an environmental management system approved to BS EN ISO 14001: 2004 (Environmental management systems. Requirements with guidance for use).

Application

Kingspan KoolDuct® rigid phenolic insulation panels are a core component of the *Kingspan KoolDuct®* System of pre-insulated ductwork, which is an alternative to traditional sheet steel ductwork in Building Services / HVAC applications. The durable and puncture resistant aluminum foil jacket on *Kingspan KoolDuct®* rigid phenolic insulation panel is used to prevent the ingress of moisture, dust and dirt into the insulation.

Availability

- Insulation panel dimensions: 12.89 ft x 3.94 ft
- Insulation panel thickness: 7/8" (R-6) & 1 3/16" (R-8.1)

General Physical Properties (Rigid Phenolic Insulation Core)

Property	Test Method	Typical Value
Color		Pink
Minimum Closed Cell Content	(BS EN ISO 4590: 2003)	≥ 90%
Nominal Density Range		3.43–3.75 pcf
Compressive Strength at 10% Compression	(BS EN 826: 1996)	29 psi
Thermal Conductivity (75°F & 50% RH)	(ASTM C 518)	0.146 Btu·in/ft ² ·hr·°F
Material R-value:		
7/8"		6.0 ft ² ·hr·°F/Btu
1 3/16"		8.1 ft ² ·hr·°F/Btu
Water Vapor Transmission (75°F & 50% RH)	(ASTM E 96)	0.34 grains/hr·ft ²
Operating Temperature Limits		-4°F to + 176°F

General Physical Properties (Aluminum Foil Vapor Barrier Jacket)

Property		Typical Value
Composition	Coated Aluminum Glass Scrim Glass Mat	1 mil 0.2" x 0.2" 30 lb/3000 ft ²
Water Vapor Transmission		0.02 perm (grains/ft ² ·hr·in·Hg)

Fire & Smoke Test Classifications (Rigid Phenolic Insulation Core & Aluminum Foil Vapor Barrier Jacket)

Test	Test Method	Result
Surface Burning Characteristics	UL 723 / ASTM E 84-08a	< 25/50*
Burning	UL 181	Pass

These results from a series of tests enables the Kingspan KoolDuct® System to be UL Listed as a Class 1 Air Duct to Standard UL 181 in accordance with NFPA (National Fire Protection Association) Standards 90A & 90B.



Appendix D2 - Insulation Performance Specifications

The installed insulation thickness shall be in accordance with the requirements of the relevant jurisdiction. (Consult the DOE (US Department of Energy) ComCheck / ResCheck or the relevant authority for applicable codes / standards).

ANSI / ASHRAE / IESNA 90.1: 2007 and IECC 2003 & 2006 are enforced by many, but not all, North American jurisdictions as the minimum ductwork insulation thickness standard.

ANSI / ASHRAE / IESNA 90.1: 2007 shows two tables with minimum required R-values for ductwork insulation operating in different climate zones and locations:

- Table 6.8.2A Heating / Cooling Only Supply & Return Ductwork; and
- Table 6.8.2B Combined Heating & Cooling Supply & Return Ductwork.

The different climate zones are shown on the map to the right.

The **Kingspan KoolDuct®** rigid phenolic insulation panel thickness and fiber glass duct wrap thickness required to achieve the specified thermal performance standards as set out in the ANSI / ASHRAE / IESNA 90.1: 2007 tables are shown below.

NB that, in some climates, the minimum energy efficiency requirements may not be sufficient for condensation control. In such cases, the risk of condensation should be assessed and calculated as appropriate.

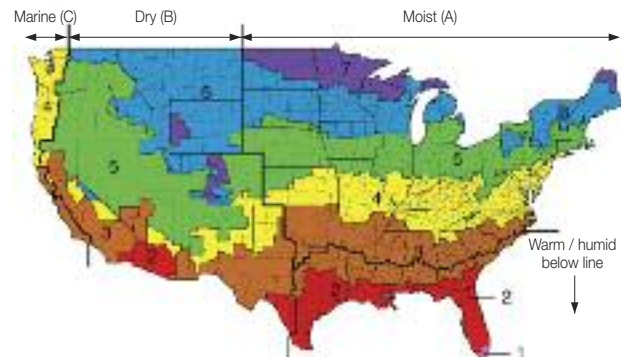

Zone 1 includes Hawaii, Guam, Puerto Rico, and the Virgin islands
 All of Alaska in Zone 7 except for the following Boroughs in Zone 8:
 Bethel Northwest Arctic Dellingham
 Southeast Fairbanks Fairbanks N. Star Wade Hampton
 Nome Yukon-Koyukuk North slope

ANSI / ASHRAE / IESNA Standard 90.1: 2007 Climate Zone Map for US Locations

Climate Zone	Different Duct Insulation Thicknesses for the Minimum Required Insulation R-values for Each Climate Zone				
	Exterior	Ventilated Attic	Unvented Attic Above Insulated Ceiling ¹	Unvented Attic with Roof Insulation ²	Unconditioned Space ³
Heating Only Ductwork					
1	R-6.0 <i>7/8" / 2 3/16"</i>	R-6.0 <i>7/8" / 2 3/16"</i>	R-8.0 <i>1 3/16" / 3"</i>	R-3.5 <i>7/8" / 1 1/2"</i>	R-3.5 <i>7/8" / 1 1/2"</i>
2	R-6.0 <i>7/8" / 2 3/16"</i>	R-6.0 <i>7/8" / 2 3/16"</i>	R-6.0 <i>7/8" / 2 3/16"</i>	R-3.5 <i>7/8" / 1 1/2"</i>	R-3.5 <i>7/8" / 1 1/2"</i>
3	R-6.0 <i>7/8" / 2 3/16"</i>	R-6.0 <i>7/8" / 2 3/16"</i>	R-6.0 <i>7/8" / 2 3/16"</i>	R-3.5 <i>7/8" / 1 1/2"</i>	R-3.5 <i>7/8" / 1 1/2"</i>
4	R-6.0 <i>7/8" / 2 3/16"</i>	R-6.0 <i>7/8" / 2 3/16"</i>	R-6.0 <i>7/8" / 2 3/16"</i>	R-3.5 <i>7/8" / 1 1/2"</i>	R-3.5 <i>7/8" / 1 1/2"</i>
5	R-6.0 <i>7/8" / 2 3/16"</i>	R-6.0 <i>7/8" / 2 3/16"</i>	R-6.0 <i>7/8" / 2 3/16"</i>	R-1.9 <i>7/8" / 1 1/2"</i>	R-3.5 <i>7/8" / 1 1/2"</i>
6	R-8.0 <i>1 3/16" / 3"</i>	R-6.0 <i>7/8" / 2 3/16"</i>	R-6.0 <i>7/8" / 2 3/16"</i>	R-1.9 <i>7/8" / 1 1/2"</i>	R-3.5 <i>7/8" / 1 1/2"</i>
7	R-8.0 <i>1 3/16" / 3"</i>	R-6.0 <i>7/8" / 2 3/16"</i>	R-6.0 <i>7/8" / 2 3/16"</i>	R-1.9 <i>7/8" / 1 1/2"</i>	R-3.5 <i>7/8" / 1 1/2"</i>
8	R-8.0 <i>1 3/16" / 3"</i>	R-8.0 <i>1 3/16" / 3"</i>	R-8.0 <i>1 3/16" / 3"</i>	R-1.9 <i>7/8" / 1 1/2"</i>	R-6.0 <i>7/8" / 2 3/16"</i>
Return Duct					
All	R-3.5 <i>7/8" / 1 1/2"</i>	R-3.5 <i>7/8" / 1 1/2"</i>	R-3.5 <i>7/8" / 1 1/2"</i>	Nil	Nil

1 Insulation R-values, measured in ft²-hr²-°F/Btu, are for the insulation as installed and do not include film resistance. The required minimum thicknesses do not consider water vapor transmission and possible surface condensation. Where exterior walls are used as plenum walls, wall insulation shall be as required by the most reflective condition of 6.4.4.2 or section 5 of ANSI / ASHRAE / IESNA 90.1: 2007. Insulation resistance measured on a horizontal plane in accordance with ASTM C 518 at a mean temperature of 75°F at the installed thickness.

2 Includes both ventilated and non ventilated crawlspaces.

3 Includes return air plenums with or without exposed roofs above.

Blue: Kingspan KoolDuct®; Assumed Installed R-value: 7/8" (R-6.0); 1 3/16" (R-8.1).

Red: Fiber Glass; Assumed Installed R-value @ 25% Compression: 1 1/2" (R-4.2); 2 3/16" (R-6.0); 3" (R-8.4).

Table D1 – Minimum Required Insulation R-value¹ for Combined Heating & Cooling Supply & Return Ductwork (Based on ANSI / ASHRAE / IESNA Standard 90.1: 2007 Table 6.8.2B)

Project Specification - Appendix D - North America



Climate Zone	Different Duct Insulation Thicknesses for the Minimum Required Insulation R-values for Each Climate Zone				
	Ductwork Location				
	Exterior	Ventilated Attic	Unvented Attic Above Insulated Ceiling ¹	Unvented Attic with Roof Insulation ²	Unconditioned Space ³
Heating Only Ductwork					
1 & 2	Nil	Nil	Nil	Nil	Nil
3	R-3.5 <i>7/8" / 1 1/2"</i>	Nil	Nil	Nil	Nil
4	R-3.5 <i>7/8" / 1 1/2"</i>	Nil	Nil	Nil	Nil
5	R-6.0 <i>7/8" / 2 3/16"</i>	R-3.5 <i>7/8" / 1 1/2"</i>	Nil	Nil	Nil
6	R-6.0 <i>7/8" / 2 3/16"</i>	R-6.0 <i>7/8" / 2 3/16"</i>	R-3.5 <i>7/8" / 1 1/2"</i>	Nil	Nil
7	R-8.0 <i>1 3/16" / 3"</i>	R-6.0 <i>7/8" / 2 3/16"</i>	R-6.0 <i>7/8" / 2 3/16"</i>	Nil	R-3.5 <i>7/8" / 1 1/2"</i>
8	R-8.0 <i>1 3/16" / 3"</i>	R-8.0 <i>1 3/16" / 3"</i>	R-8.0 <i>1 3/16" / 3"</i>	Nil	R-6.0 <i>7/8" / 2 3/16"</i>
Cooling Only Ductwork					
1	R-6.0 <i>7/8" / 2 3/16"</i>	R-6.0 <i>7/8" / 2 3/16"</i>	R-8.0 <i>1 3/16" / 3"</i>	R-3.5 <i>7/8" / 1 1/2"</i>	R-3.5 <i>7/8" / 1 1/2"</i>
2	R-6.0 <i>7/8" / 2 3/16"</i>	R-6.0 <i>7/8" / 2 3/16"</i>	R-6.0 <i>7/8" / 2 3/16"</i>	R-3.5 <i>7/8" / 1 1/2"</i>	R-3.5 <i>7/8" / 1 1/2"</i>
3	R-6.0 <i>7/8" / 2 3/16"</i>	R-6.0 <i>7/8" / 2 3/16"</i>	R-6.0 <i>7/8" / 2 3/16"</i>	R-3.5 <i>7/8" / 1 1/2"</i>	R-1.9 <i>7/8" / 1 1/2"</i>
4	R-3.5 <i>7/8" / 1 1/2"</i>	R-3.5 <i>7/8" / 1 1/2"</i>	R-6.0 <i>7/8" / 2 3/16"</i>	R-1.9 <i>7/8" / 1 1/2"</i>	R-1.9 <i>7/8" / 1 1/2"</i>
5 & 6	R-3.5 <i>7/8" / 1 1/2"</i>	R-1.9 <i>7/8" / 1 1/2"</i>	R-3.5 <i>7/8" / 1 1/2"</i>	R-1.9 <i>7/8" / 1 1/2"</i>	R-1.9 <i>7/8" / 1 1/2"</i>
7 & 8	R-1.9 <i>7/8" / 1 1/2"</i>	R-1.9 <i>7/8" / 1 1/2"</i>	R-1.9 <i>7/8" / 1 1/2"</i>	R-1.9 <i>7/8" / 1 1/2"</i>	R-1.9 <i>7/8" / 1 1/2"</i>
Return Ductwork					
All	R-3.5 <i>7/8" / 1 1/2"</i>	R-3.5 <i>7/8" / 1 1/2"</i>	R-3.5 <i>7/8" / 1 1/2"</i>	Nil	Nil

¹ Insulation R-values, measured in ft²-hr²-°F/Btu, are for the insulation as installed and do not include film resistance. The required minimum thicknesses do not consider water vapor transmission and possible surface condensation. Where exterior walls are used as plenum walls, wall insulation shall be as required by the most reflective condition of 6.4.4.2 or section 5 of ANSI / ASHRAE / IESNA 90.1: 2007. Insulation resistance measured on a horizontal plane in accordance with ASTM C 518 at a mean temperature of 75°F at the installed thickness.

² Includes both ventilated and non ventilated crawlspaces.

³ Includes return air plenums with or without exposed roofs above.

Blue: Kingspan **KoolDuct**®. Assumed Installed R-value: 7/8" (R-6.0); 1 3/16" (R-8.1).

Red: Fiber Glass: Assumed Installed R-value @ 25% Compression: 1 1/2" (R-4.2); 2 3/16" (R-6.0); 3" (R-8.4).

Table D2 – Minimum Required Insulation R-value¹ for Heating & Cooling Only Supply & Return Ductwork (Based on ANSI / ASHRAE / IESNA Standard 90.1: 2007 Table 6.8.2A)

It can be seen from the tables above that:

- in all circumstances shown that the 7/8" (R-6.0) and 1 3/16" (R-8.1) thick rigid phenolic insulation panels used in the **Kingspan KoolDuct**® System match or exceed the specification laid down in ANSI / ASHRAE / IESNA 90.1: 2007 and IECC 2003 & 2006; and
- the thickness of the 7/8" and 1 3/16" thick rigid phenolic insulation panels used in the **Kingspan KoolDuct**® System can be significantly less than the required thickness of fiber glass (up to 60% thinner).



Appendix D3 - Fire & Smoke Performance

The appropriate fire and smoke performance requirements for North America are:

- ASTM E 84-08a – unfaced or composite (insulation, facing and adhesive) of low contribution to fire growth not exceeding 25 Flame Spread and 50 Smoke Developed indices;
- UL 723 – unfaced or composite (insulation, facing and adhesive) of low contribution to fire growth not exceeding 25 Flame Spread and 50 Smoke Developed indices; and
- UL 181 – UL/ULC classification as a Class 1 Air Duct to NFPA Standards 90A & 90B.

Appendix D4 - Air Leakage Limits

Ductwork system air leakage shall be in accordance with the requirements of the relevant jurisdiction. (Consult the DOE (US Department of Energy) ComCheck / ResCheck or the relevant authority for applicable codes / standards).

Ductwork installations are required to be made sufficiently airtight to ensure quiet and economical operation of the system. The SMACNA HVAC Air Duct Leakage Test Manual, ANSI / ASHRAE / IESNA 90.1: 2007 and IECC 2003 & 2006 are referred to in many, but not all, specifications in order to determine the air leakage limits for ductwork systems.

The maximum allowable air leakage for all Class 6 (C_L6) rectangular ducts is $6 \times P^{0.65}$ as defined by ANSI / ASHRAE / IESNA 90.1 and IECC 2003 & 2006 section 503.2.7.

The SMACNA HVAC Air Duct Leakage Test Manual details the maximum allowable air leakage as shown in the table below:

Seal Class	Air Leakage Class (C_L)	Static Pressure (in.w.g.)	Air Leakage Limits (cfm/100 sq.ft)
A	6	≥ 4	$6 \times p^{0.65}$
B	12	3	$12 \times p^{0.65}$
C	24	≤ 2	$24 \times p^{0.65}$

p = static pressure (in.w.g.)

Based on the limits set out in table above, the maximum allowable air leakage for each pressure and seal class is plotted in the graph above right over a range of pressures from 0–4 in.w.g. The leakage figures are given in cubic feet of air per minute per one hundred square feet (cfm/100 sq. ft) of internally measured ductwork against a static pressure ranging from 0–4 in.w.g.

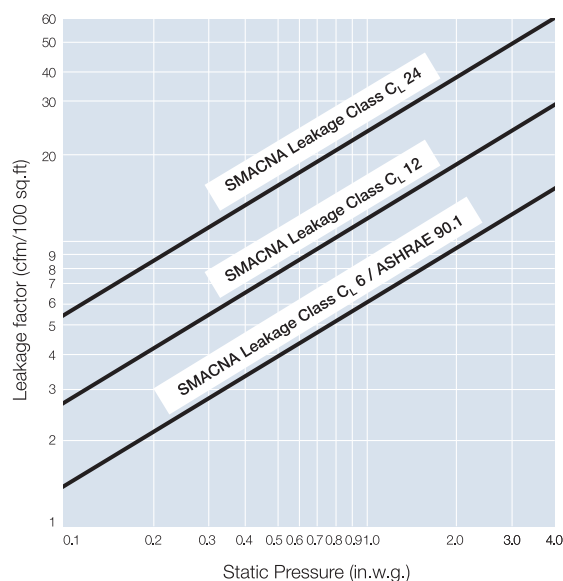

Appendix D5 - Ductwork Fittings

The appropriate ductwork construction standard for North America is the ASHRAE Design Fundamentals Handbook Chapter 35 or SMACNA HVAC Duct System Design Manual.

Appendix D6 - Finishes

Internal Ductwork

The finish shall be either:

- aluminum / zinc alloy coated sheet steel (0.024") which can be introduced during fabrication of the ductwork or installed in place; or
- a suitable paint finish (must not compromise factory applied reinforced aluminum facing or fire classification) applied in place.

External Ductwork

The finish shall be either:

- an aluminum cladding / jacketing system which can be introduced during fabrication of the ductwork or installed in place;
- aluminum / zinc alloy coated sheet steel (0.032") which can be introduced during fabrication of the ducting or installed in place;
- a fiber reinforced plastic which is introduced during the fabrication of the ductwork;
- a polymeric weather covering (for sheltered locations) installed in place; or
- no. 10 open weave glass cloth embedded between two coats of trowel applied mastic.



Appendix D7 - Testing for Air Leakage

Ductwork air leakage testing shall be carried out in accordance with the requirements of the relevant jurisdiction.

ANSI / ASHRAE / IESNA 90.1 requires that ductwork designed to operate at static pressures > 3 in.w.g be tested for air leakage and that testing is performed on \geq 25% of the total installed duct area. It refers to the SMACNA HVAC Air Duct Leakage Manual as an industry accepted test procedure for air leakage.

The SMACNA HVAC Air Duct Leakage Test Manual does not require testing for air leakage where adequate methods of assembly and sealing are used. It recommends the following:

- high pressure ducts \geq 4 in.w.g. – tested, if justified by the designer; and
- low – medium pressure ducts \leq 3 in.w.g. – untested.

Appendix D8 - Standards / References

American Standards

ASTM C 518: 2004

Standard Test Method for Steady-State Thermal Transmission Properties by Means of the Heat Flow Meter Apparatus

ASTM E96 / E96M-05

Standard Test Methods for Water Vapor Transmission of Materials

ASTM E 84-08a

Standard Test Method for Surface Burning Characteristics of Building Materials

UL 723

Test for Surface Burning Characteristics of Building Materials

NFPA 90A

Standard for the Installation of Air Conditioning and Ventilating Systems

NFPA 90B

Standard for the Installation of Warm Air Heating and Air-Conditioning Systems

UL/ULC 181

Standard for Safety Factory Made Air Ducts and Connectors

British Standards

BS EN 826:1996

Thermal insulating products for building applications. Determination of compression behaviour

BS EN ISO 4590: 2003

Rigid cellular plastics. Determination of the volume percentage of open cells and of closed cells

BS EN ISO 9001: 2000

Quality management systems. Requirements

BS EN ISO 14001: 2004

Environmental management systems. Requirements with guidance for use)

Other References

US Department of Energy (DOE)

ComCheck & ResCheck

ANSI / ASHRAE / IESNA 90.1: 2007

Energy Standard for Buildings Except Low-Rise Residential Buildings Sections 5 & 6

ASHRAE Design Fundamentals Handbook Chapter 35

SMACNA HVAC Duct System Design Manual

SMACNA HVAC Duct Construction Standard

SMACNA HVAC Air Duct Leakage Test manual

Building Codes

The IECC (International Energy Conservation Code) 2003 & 2006

The IECC (International Energy Conservation Code) 2003 & 2006 503.2.7

Contact Details

UK & Ireland

For all enquiries, please contact Kingspan Insulation Ltd. as follows:

UK – Tel: +44 (0) 870 850 8555
– Fax: +44 (0) 870 850 8666
– email: info.uk@insulation.kingspan.com

Ireland – Tel: +353 (0) 42 97 54200
– Fax: +353 (0) 42 97 54299
– email: info.ie@insulation.kingspan.com



Kingspan Insulation Ltd. is a member of the Association of Ductwork Contractors and Allied Services (ADCAS)



Kingspan Insulation Ltd. is an affiliate of the Heating and Ventilating Contractors' Association (HVCA)

North America

For all enquiries, please contact Kingspan Insulation Ltd. as follows:

– Tel: +44 (0) 870 850 8555
– Fax: +44 (0) 870 850 8666
– email: info.na@insulation.kingspan.com



Kingspan Insulation Ltd. is a member of the Sheet Metal & Air Conditioning Contractors' National Association (SMACNA)

Australia

For all enquiries, please contact Kingspan Insulation Ltd. as follows:

– 38–52 Dunhevan Circuit, St. Marys, NSW 2760
– Tel: +61 (0) 2 9673 5069
– Fax: +61 (0) 2 9673 5068
– email: info.au@insulation.kingspan.com

Middle East

For all enquiries, please contact Kingspan Insulation Ltd. as follows:

– Tel: +44 (0) 870 850 8555
– Fax: +44 (0) 870 850 8666
– email: info.me@insulation.kingspan.com

Kingspan Insulation Ltd. reserves the right to amend product specifications without prior notice. Product thicknesses shown in this document should not be taken as being available ex-stock and reference should be made to the current Kingspan Insulation price-list or advice sought from Kingspan Insulation's Customer Service Department (see above left). The information, technical details and fixing instructions etc. included in this literature are given in good faith and apply to uses described. Recommendations for use should be verified as to the suitability and compliance with actual requirements, specifications and any applicable laws and regulations. For other applications or conditions of use, Kingspan Insulation offers a Technical Advisory Service (see left) the advice of which should be sought for uses of Kingspan Insulation products that are not specifically described herein. Please check that your copy of the literature is current by contacting the Kingspan Insulation Marketing Department (see above).

Your local supplier is:



Kingspan Insulation Ltd

Pembridge, Leominster, Herefordshire HR6 9LA, UK
Castleblayney, County Monaghan, Ireland

www.insulation.kingspan.com